

V1-1W Series



1W Unregulated Single & Dual output

Features

- 7 Pin SIL / 14 Pin DIL Package
- 1000 VDC Isolation
- Up to 6000 VDC Isolation
- Low Ripple and Noise
- Efficiency up to 80%
- -40 ~ 85°C Operation Temperature Range
- Non-Conductive Black Plastic Case
- EN55022 CLASS B For SIP Series



The V1 series is a family of cost effective 1W single & dual output DC DC converters. These converters achieve low cost and ultra miniature SIP 7 pin or DIP 14 pin size. Devices are encapsulated using flame retardant resin. The models operate from input voltage of 5, 12, 24, 48 Vdc with output voltage of 3.3, 5, 7.2, 9, 12, 15, 18, 24, ±3.3, ±5, ±7.2, ±9, ±12, ±15, ±18, ±24 Vdc. High performance features include 1000Vdc~6000Vdc input/output isolation, high efficiency operation and output voltage accuracy of ±3% maximum. Standard features include an input range of ±10% tolerance and low output noise and ripple.

All specifications typical at Ta=25°C, nominal input voltage and full load unless otherwise specified

OUTPUT SPECIFICATIONS	
Voltage accuracy	±3%
Line regulation	±1.2% / Per 1% Vin Change
Load regulation	(From 20% to 100% Load) ±10% (Output 3.3V Model) ±20%
Ripple & noise (20 MHz bandwidth)(1)	75mV pk pk
Temperature coefficient	±0.02%/°C
Capacitor load(2)	See table

INPUT SPECIFICATIONS	
Voltage Range	±10%
Max. Input Current	See table
No Load Input Current	See table
Input Filter	Capacitors
Input Reflected Ripple Current(3)	20mA pk pk

GENERAL SPECIFICATIONS	
Efficiency	See table
I/O Isolation Voltage(3 sec)	
Input/Output	1000~6000Vdc
I/O Isolation Capacitance	60 pF Typ.
I/O Isolation Resistance	1000M Ohm
Switching Frequency	Variable 80kHz
Humidity	95% rel H
Reliability Calculated MTBF(MIL-HDBK-217 F)	>1.121 Mhrs
Safety Standard : (designed to meet)	IEC 60950 1

EMC SPECIFICATIONS (For SIP Series)		
Radiated Emissions	EN55022	CLASS B
	FCC 47 CFR Part 15 Subpart A	CLASS B
ESD	IEC 61000 4 2	Perf. Criteria B
RS	IEC 61000 4 3	Perf. Criteria A

PHYSICAL SPECIFICATIONS	
Case Material	Non conductive Black Plastic (UL94V 0 rated)
Pin Material	0.5mm Alloy 42 Solder coated
Potting Material	Epoxy (UL94V 0 rated)
Weight	(SIP/2.3g) (DIP/2.6g)
Dimensions	SIP Case 0.76"x0.24"x0.39" DIP Case 0.80"x0.40"x0.27"

ENVIRONMENT SPECIFICATIONS	
Operating Temperature	40°C~85°C (See Derating Curve)
Maximum Case Temperature	100°C
Storage Temperature	40°C~125°C
Cooling	Nature Convection

ABSOLUTE MAXIMUM RATINGS(4)	
These are stress ratings. Exposure of devices to any of these conditions may adversely affect long term reliability.	
Input Voltage(100ms)	
5 Modes	0~7 Vdc
12 Modes	0~15 Vdc
24 Modes	0~28 Vdc
48 Modes	0~54 Vdc
Lead Soldering Temperature (1.5mm from case 10sec.)	260°C

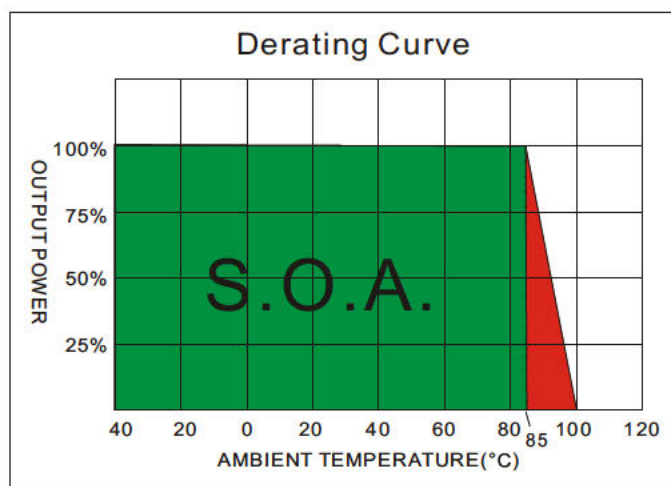
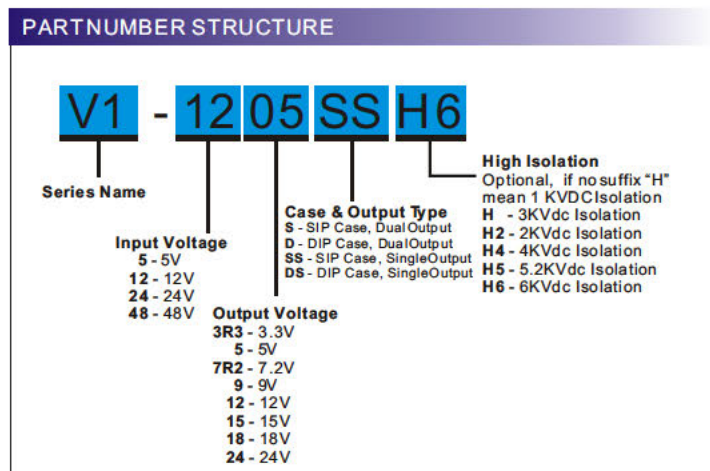

MODEL SELECTION GUIDE

MODEL NUMBER	INPUT Voltage Range (Vdc)	INPUT Current		OUTPUT Voltage (Vdc)	OUTPUT Current Full load (mA)	EFFICIENCY @FL(%)	Capacitor Load(uF)
		No Load (mA)	Full Load (mA)				
V1 053R3S	5	30	307	±3.3	±151.5	65	±100
V1 0505S	5	30	270	±5	±100	74	±100
V1 057R2S	5	30	259	±7.2	±69.44	77	±100
V1 0509S	5	30	256	±9	±55.55	78	±100
V1 0512S	5	30	256	±12	±41.67	78	±100
V1 0515S	5	30	250	±15	±33.33	80	±100
V1 0518S	5	30	253	±18	±27.77	79	±100
V1 0524S	5	30	250	±24	±20.83	80	±100
V1 123R3S	12	20	126	±3.3	±151.5	66	±100
V1 1205S	12	20	111	±5	±100	75	±100
V1 127R2S	12	20	109	±7.2	±69.44	76	±100
V1 1209S	12	20	109	±9	±55.55	76	±100
V1 1212S	12	20	106	±12	±41.67	78	±100
V1 1215S	12	20	104	±15	±33.33	80	±100
V1 1218S	12	20	104	±18	±27.77	80	±100
V1 1224S	12	20	109	±24	±20.83	76	±100
V1 243R3S	24	10	61	±3.3	±151.5	68	±100
V1 2405S	24	10	56	±5	±100	74	±100
V1 247R2S	24	10	54	±7.2	±69.44	76	±100
V1 2409S	24	10	54	±9	±55.55	76	±100
V1 2412S	24	10	53	±12	±41.67	78	±100
V1 2415S	24	10	53	±15	±33.33	78	±100
V1 2418S	24	10	53	±18	±27.77	78	±100
V1 2424S	24	10	53	±24	±20.83	78	±100
V1 483R3S	48	6	34	±3.3	±151.5	60	±100
V1 4805S	48	6	30	±5	±100	70	±100
V1 487R2S	48	6	30	±7.2	±69.44	70	±100
V1 4809S	48	6	29	±9	±55.55	72	±100
V1 4812S	48	6	28	±12	±41.67	74	±100
V1 4815S	48	6	28	±15	±33.33	74	±100
V1 4818S	48	6	29	±18	±27.77	72	±100
V1 4824S	48	6	30	±24	±20.83	70	±100

Suffix "H" means 3 KVdc isolation
Suffix "H5" means 5.2 KVdc isolation

Suffix "H2" means 2 KVdc isolation
Suffix "H6" means 6 KVdc isolation

Suffix "H4" means 4 KVdc isolation

V1 -1W Unregulated Single & Dual output

MODEL NUMBER	INPUT Voltage Range (Vdc)	INPUT Current		OUTPUT Voltage (Vdc)	OUTPUT Current		EFFICIENCY @FL(%)	Capacitor Load(uF)
		No Load (mA)	Full Load (mA)		Full load (mA)			
V1 053R3D	5	30	307	±3.3	±151.5	65	±100	
V1 0505D	5	30	270	±5	±100	74	±100	
V1 057R2D	5	30	259	±7.2	±69.44	77	±100	
V1 0509D	5	30	256	±9	±55.55	78	±100	
V1 0512D	5	30	256	±12	±41.67	78	±100	
V1 0515D	5	30	250	±15	±33.33	80	±100	
V1 0518D	5	30	256	±18	±27.77	78	±100	
V1 0524D	5	30	266	±24	±20.83	75	±100	
V1 123R3D	12	20	126	±3.3	±151.5	66	±100	
V1 1205D	12	20	111	±5	±100	75	±100	
V1 127R2D	12	20	115	±7.2	±69.44	72	±100	
V1 1209D	12	20	111	±9	±55.55	75	±100	
V1 1212D	12	20	106	±12	±41.67	78	±100	
V1 1215D	12	20	106	±15	±33.33	78	±100	
V1 1218D	12	20	111	±18	±27.77	75	±100	
V1 1224D	12	20	111	±24	±20.83	75	±100	
V1 243R3D	24	10	62	±3.3	±151.5	67	±100	
V1 2405D	24	10	57	±5	±100	72	±100	
V1 247R2D	24	10	59	±7.2	±69.44	70	±100	
V1 2409D	24	10	55	±9	±55.55	75	±100	
V1 2412D	24	10	53	±12	±41.67	78	±100	
V1 2415D	24	10	55	±15	±33.33	75	±100	
V1 2418D	24	10	57	±18	±27.77	72	±100	
V1 2424D	24	10	59	±24	±20.83	70	±100	
V1 053R3SS	5	30	267	3.3	303	75	220	
V1 0505SS	5	30	256	5	200	78	220	
V1 057R2SS	5	30	270	7.2	138.9	74	220	
V1 0509SS	5	30	267	9	111.1	75	220	
V1 0512SS	5	30	263	12	83.3	76	220	
V1 0515SS	5	30	263	15	66.7	76	220	
V1 0518SS	5	30	267	18	55.6	75	220	
V1 0524SS	5	30	278	24	41.7	72	220	
V1 123R3SS	12	20	113	3.3	303	74	220	
V1 1205SS	12	20	113	5	200	74	220	
V1 127R2SS	12	20	113	7.2	138.9	74	220	
V1 1209SS	12	20	111	9	111.1	75	220	
V1 1212SS	12	20	108	12	83.3	77	220	
V1 1215SS	12	20	106	15	66.7	78	220	
V1 1218SS	12	20	106	18	55.6	78	220	
V1 1224SS	12	20	113	24	41.7	75	220	
V1 243R3SS	24	10	56	3.3	303	75	220	
V1 2405SS	24	10	54	5	200	77	220	
V1 247R2SS	24	10	56	7.2	138.9	75	220	
V1 2409SS	24	10	56	9	111.1	75	220	
V1 2412SS	24	10	53	12	83.3	78	220	
V1 2415SS	24	10	53	15	66.7	78	220	
V1 2418SS	24	10	53	18	55.6	78	220	
V1 2424SS	24	10	53	24	41.7	78	220	

Suffix "H" means 3 KVdc isolation
 Suffix "H5" means 5.2 KVdc isolation

Suffix "H2" means 2 KVdc isolation
 Suffix "H6" means 6 KVdc isolation

Suffix "H4" means 4 KVdc isolation

V1 -1W Unregulated Single & Dual output

MODEL NUMBER	INPUT Voltage Range (Vdc)	INPUT Current		OUTPUT Voltage (Vdc)	OUTPUT Current Full load (mA)	EFFICIENCY @FL(%)	Capacitor Load(uF)
		No Load (mA)	Full Load (mA)				
V1 483R3SS	48	6	29	3.3	303	72	220
V1 4805SS	48	6	29	5	200	72	220
V1 487R2SS	48	6	29	7.2	138.9	72	220
V1 4809SS	48	6	28	9	111.1	74	220
V1 4812SS	48	6	28	12	83.3	74	220
V1 4815SS	48	6	28	15	66.7	75	220
V1 4818SS	48	6	29	18	55.6	72	220
V1 4824SS	48	6	30	24	41.7	70	220
V1 053R3DS	5	30	267	3.3	303	75	220
V1 0505DS	5	30	256	5	200	78	220
V1 057R2DS	5	30	267	7.2	138.9	75	220
V1 0509DS	5	30	267	9	111.1	75	220
V1 0512DS	5	30	263	12	83.3	76	220
V1 0515DS	5	30	263	15	66.7	76	220
V1 0518DS	5	30	267	18	55.6	75	220
V1 0524DS	5	30	278	24	41.7	72	220
V1 123R3DS	12	20	113	3.3	303	74	220
V1 1205DS	12	20	113	5	200	74	220
V1 127R2DS	12	20	113	7.2	138.9	74	220
V1 1209DS	12	20	111	9	111.1	75	220
V1 1212DS	12	20	108	12	83.3	77	220
V1 1215DS	12	20	106	15	66.7	78	220
V1 1218DS	12	20	106	18	55.6	78	220
V1 1224DS	12	20	111	24	41.7	75	220
V1 243R3DS	24	10	56	3.3	303	75	220
V1 2405DS	24	10	54	5	200	77	220
V1 247R2DS	24	10	56	7.2	138.9	75	220
V1 2409DS	24	10	56	9	111.1	75	220
V1 2412DS	24	10	53	12	83.3	78	220
V1 2415DS	24	10	53	15	66.7	78	220
V1 2418DS	24	10	53	18	55.6	78	220
V1 2424DS	24	10	53	24	41.7	78	220

Suffix "H" means 3 KVdc isolation Suffix "H2" means 2 KVdc isolation Suffix "H4" means 4 KVdc isolation
 Suffix "H5" means 5.2 KVdc isolation Suffix "H6" means 6 KVdc isolation

NOTE

1. Ripple/Noise measured with 20MHz bandwidth.
2. Tested by minimal Vin and constant resistive load.
3. Measured Input reflected ripple current with a simulated source inductance of 12uH.
4. Exceeding the absolute ratings of the unit could cause damage. It is not allowed for continuous operating.
5. Operation under no load conditions will not damage these devices, however they may not meet all listed specifications.
6. For reduce converter's ripple & noise, it is recommended to add a 4.7µF~100µF(±4.7µF~±68µF for dual output) capacitor in output end. For EMI performance improvement, it is recommended to add a 12µH inductor and a 10µF~100µF capacitor in input end.

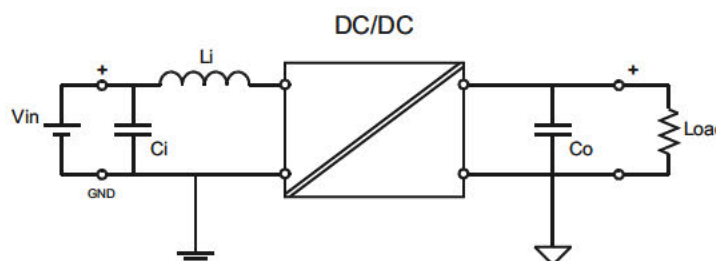

V1 -1W Unregulated Single & Dual output

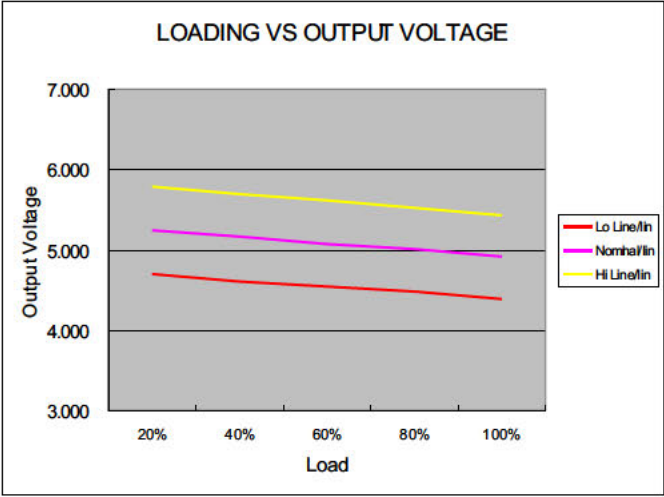

5 Models

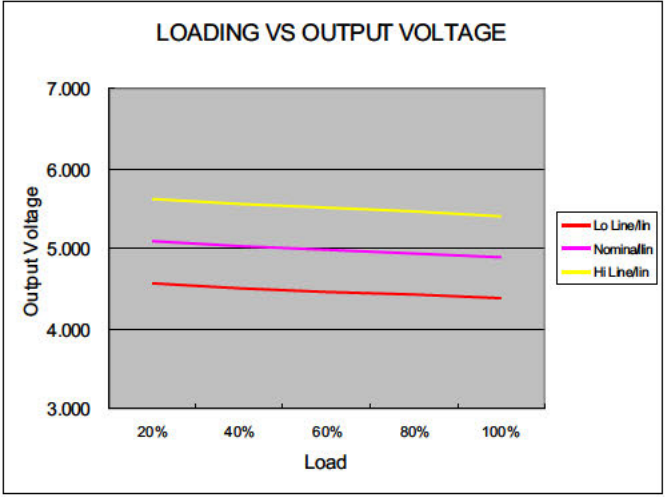

12 Models

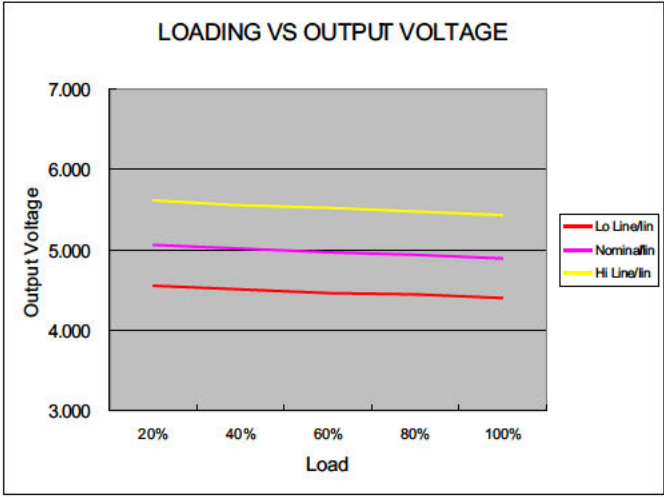

24 Models

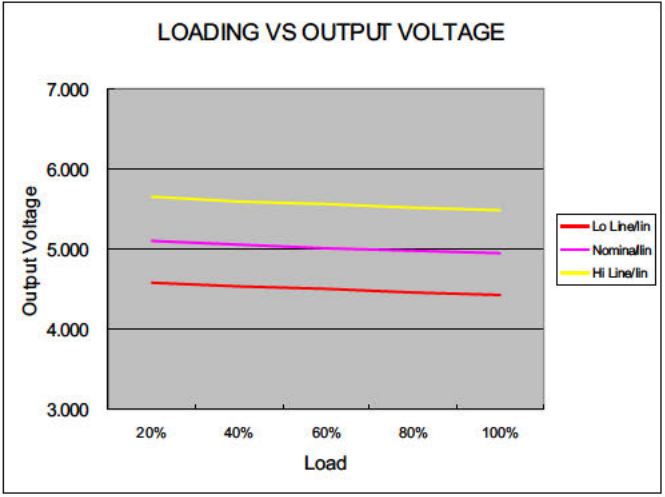

48 Models

MECHANICAL SPECIFICATIONS

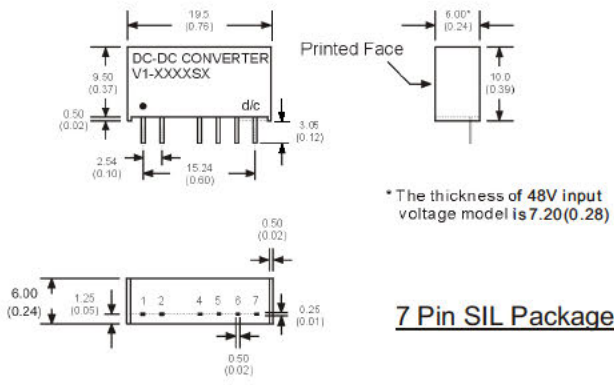

PIN CONNECTIONS				
PIN NUMBER	SINGLE	DUAL	SINGLE-H	DUAL-H
1	+V Input	+V Input	+V Input	+V Input
2	-V Input	-V Input	-V Input	-V Input
4	-V Output	-V Output	N.P.	N.P.
5	N.P.	Common	-V Output	-V Output
6	+V Output	+V Output	N.P.	Common
7	N.P.	N.P.	+V Output	+V Output

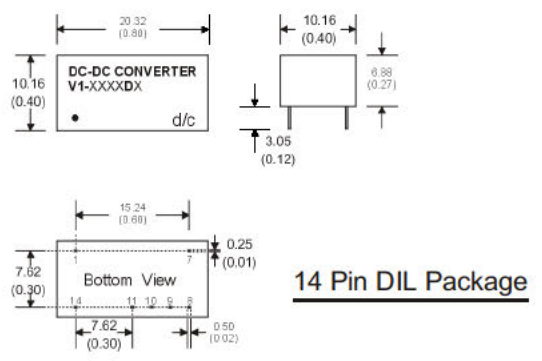

PIN CONNECTIONS				
PIN NUMBER	SINGLE	DUAL	SINGLE-H	DUAL-H
1	-V Input	-V Input	-V Input	-V Input
7	N.C.	N.C.	N.C.	N.C.
8	N.P.	Common	+V Output	+V Output
9	+V Output	+V Output	N.P.	Common
10	N.P.	N.P.	-V Output	-V Output
11	-V Output	-V Output	N.P.	N.P.
14	+V Input	+V Input	+V Input	+V Input

Notes : All dimensions are typical in millimeters (inches).
 1. Pin diameter: 0.5 ± 0.05 (0.02 ± 0.002)
 2. Pin pitch tolerance: ± 0.35 (± 0.014)
 3. Case Tolerance: ± 0.5 (± 0.02)