

SCHMID-M

SUMFS SERIES

50-66 Watt DC-DC Converters

- ◆ 2:1 \ 4:1 Input Range
- ◆ 50-66 W Isolated Output Power
- ◆ High-Density
- ◆ Enclosure type
- ◆ Standard 1-16th Package
- ◆ 1600 \ 2250VDC input to output basic insulation
- ◆ RoHS Compliant



SPECIFICATIONS

All specifications are typical at nominal line, full load, airflow rate= 300LFM and 25°C unless otherwise noted.

INPUT SPECIFICATIONS

Input Voltage Range, 2:1 Range, 24V	18-36V
48V	36-75V
4:1 Range, 24V	9-36V
48V	18-75V
Input Voltage peak/surge, 24	40V/Continuous
	50V/100ms max.
48	80V/Continuous
	100V/100ms max.
Input Turn-On Voltage, 2:1 Range, 24V	18 VDC max.
48V	35 VDC max.
4:1 Range, 24V	9 VDC max.
48V	18 VDC max.
Input Undervoltage Shutdown,	
2:1 Range, 24V	15 VDC typ.
48V	30 VDC typ.
4:1 Range, 24V	8 VDC typ.
48V	16 VDC typ.

OUTPUT SPECIFICATIONS

Voltage Accuracy ¹	±2% max.
External Trim Adj. Range	+/-10% typ.
Transient Response ²	
Single, 25% step Load Change	<500u sec.
Short Circuit Protection	Continuous
Line Regulation ³	±1% max.
Load Regulation ⁴	±2% max.
Ripple and Noise, 20MHz BW ⁵	150mV p-p max.
Overvoltage Protection ⁶ , 3.3V	4.3V typ.
5.0V	6.3V typ.
12V	15V typ.
15V	17V typ.
24V	28V typ.
28V	33V typ.

GENERAL SPECIFICATIONS

Efficiency	See Table
Isolation Voltage	2250 VDC min.
Switch Frequency, 2:1 Range,	500KHz typ.
4:1 Range,	440KHz typ.
Isolation Resistance ⁷	10 ⁸ Ohms min.
Over temperature shutdown point ^{8,9} ,	
Multilayer Type	128°C typ.
Enclosure Type	110°C typ.

Operation Temperature ⁹	-40°C to +110°C
Storage Temperature Range	-55°C to +125°C
EMI/RFI Conducted ¹⁰	EN55022 Level A/B
Dimensions, M type	1.30*0.90*0.39 inches
	(33.0*22.9*10.0 mm)
E type	1.44*1.04*0.50 inches
	(36.5*26.3*12.7 mm)
Weight, M type	14g
E type	27g

APPLICATIONS

Railway /Transportation System
 Wireless Network
 Telecom /Datacom System
 Industry Control System
 Workstation, Servers

NOTE

1. Defined at the static output regulation at 25°C, including initial setting accuracy, Line voltage within stated limits and load current within stated limits.
2. di/dt= 100mA/1uS, Tc= 25°C; load change= 0.5Io max. to 0.75 Io max. and 0.75 Io max. to 0.5 Io max.
3. Measured from high line to low line.
4. Measured from full load to 1/4 load.
5. Measured with 4.7uF ceramic Cap. and 47uF POSCAP cross to output.
6. The converter will automatically restart after the overvoltage status be removed.
7. Measured with 500 VDC.
8. Non-latching shutdown protection has 10°C restart hysteresis.
9. Defined as the highest temperature measured at any one of the specified temperature hotspot checkpoints.
10. Test with external Input filter.
11. A 220uF E-Cap is recommended to be added in the input terminal for stabilize input voltage source.
12. This power module is not internally fused. An input line fuse must always be used.
13. If the remote sense is not needed +sense should be connected to +out and -sense should be connected to -out.
14. This converter can operating at no load condition but 10% loading on the output is preferred to maintain specified regulation operation. Under no load conditions will not damage these devices, However they may not meet all listed specification.

REMOTE ON/OFF CONTROL	
Logic Compatibility.....	CMOS or Open Collector TTL
Ec-ON	> +2.5 VDC or Open Circuit
Ec-OFF	< 0.8 VDC
Control Common	Referenced to Input Minus

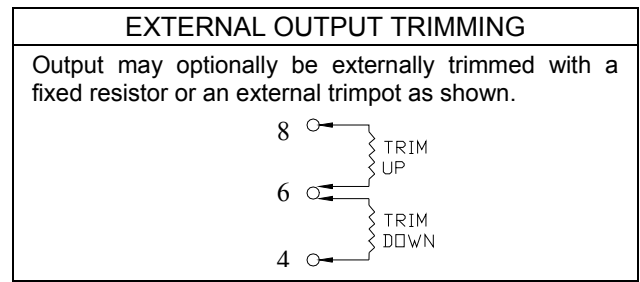

MODEL NUMBER	INPUT VOLTAGE	OUTPUT VOLTAGE	OUTPUT CURRENT	INPUT CURRENT FULL LOAD	TYPICAL EFFICIENCY	Maximum Capacitive Load (uF)
SUMFS050E3RSP03	9-36 VDC	3.3 VDC	12A@ 9-18VDC	5.2A@ 9 VDC	88 %@12 VDC	10000
			15A@18-36VDC	3.20A@18 VDC	90 %@24 VDC	
SUMFS050E3RSP05	9-36 VDC	5.0 VDC	8A@ 9-18VDC	5.2A@ 9 VDC	88 %@12 VDC	5000
			10A@18-36VDC	3.20A@18 VDC	90 %@24 VDC	
SUMFS050E3RSP12	9-36 VDC	12 VDC	3.5A@ 9-18VDC	5.6A@ 9 VDC	86 %@12 VDC	2200
			4.2A@18-36VDC	3.26A@18 VDC	88 %@24 VDC	
SUMFS050E3RSP15	9-36 VDC	15 VDC	2.8A@ 9-18VDC	5.6A@ 9 VDC	86 %@12 VDC	1000
			3.4A@18-36VDC	3.26A@18 VDC	88 %@24 VDC	
SUMFS050E3RSP24	9-36 VDC	24 VDC	1.8A@ 9-18VDC	5.55A@ 9 VDC	90 %@12 VDC	1000
			2.1A@18-36VDC	3.20A@18 VDC	91 %@24 VDC	
SUMFS050E3RSP28	9-36 VDC	28 VDC	1.5A@ 9-18VDC	5.30A@ 9 VDC	91 %@12 VDC	1000
			1.8A@18-36VDC	3.15A@18 VDC	92 %@24 VDC	
SUMFS050E4RSP03	18-75 VDC	3.3 VDC	12A@18-36VDC	2.50A@18 VDC	89 %@24 VDC	10000
			15A@36-75VDC	1.6A@36 VDC	90 %@48 VDC	
SUMFS050M4SP05	18-75 VDC	5.0 VDC	8A@18-36VDC	2.50A@18 VDC	89 %@24 VDC	5000
			10A@36-75VDC	1.6A@36 VDC	90 %@48 VDC	
SUMFS050E4RSP12	18-75 VDC	12 VDC	3.5A@18-36VDC	2.72A@18 VDC	88 %@24 VDC	2200
			4.2A@36-75VDC	1.6A@36 VDC	90 %@48 VDC	
SUMFS050E4RSP15	18-75 VDC	15 VDC	2.8A@18-36VDC	2.72A@18 VDC	88 %@24 VDC	1000
			3.4A@36-75VDC	1.6A@36 VDC	90 %@48 VDC	
SUMFS050E4RSP24	18-75 VDC	24 VDC	1.8A@18-36VDC	2.70A@18 VDC	90 %@24 VDC	1000
			2.1A@36-75VDC	1.56A@36 VDC	91 %@48 VDC	
SUMFS050E4RSP28	18-75 VDC	28 VDC	1.5A@18-36VDC	2.60A@18 VDC	91 %@24 VDC	1000
			1.8A@36-75VDC	1.54A@36 VDC	92 %@48 VDC	
SUMFS066E1RSP03	18-36 VDC	3.3 VDC	20 A	4.4 A@18 VDC	87 %	10000
SUMFS060E1RSP05	18-36 VDC	5.0 VDC	12 A	3.9 A@18 VDC	89 %	10000
SUMFS060E1RSP12	18-36 VDC	12 VDC	5 A	3.85 A@18 VDC	90 %	2200
SUMFS060E1RSP15	18-36 VDC	15 VDC	4 A	3.85 A@18 VDC	90 %	1000
SUMFS060E1RSP24	18-36 VDC	24 VDC	2.5A	3.75 A@18 VDC	91 %	1000
SUMFS060E1RSP28	18-36 VDC	28 VDC	2.15A	3.75 A@18 VDC	91 %	1000
SUMFS066E2RSP03	36-75 VDC	3.3 VDC	20 A	1.57 A	88 %	10000
SUMFS060E2RSP05	36-75 VDC	5.0 VDC	12 A	1.40 A	90 %	10000

Note: Other output voltage can be supported upon request.

SUMFS050 Case temperature curve

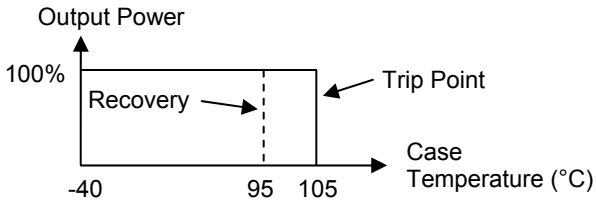

SUMFS060 Case temperature curve

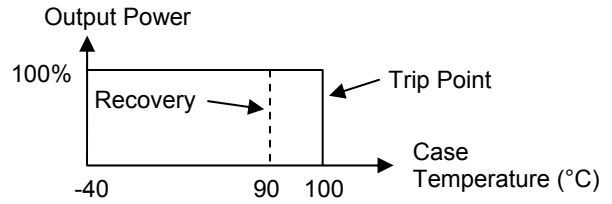

PART NUMBERING SYSTEM

The part numbering system for SCHMID-M DC-DC converters follow the format shown in the example below.

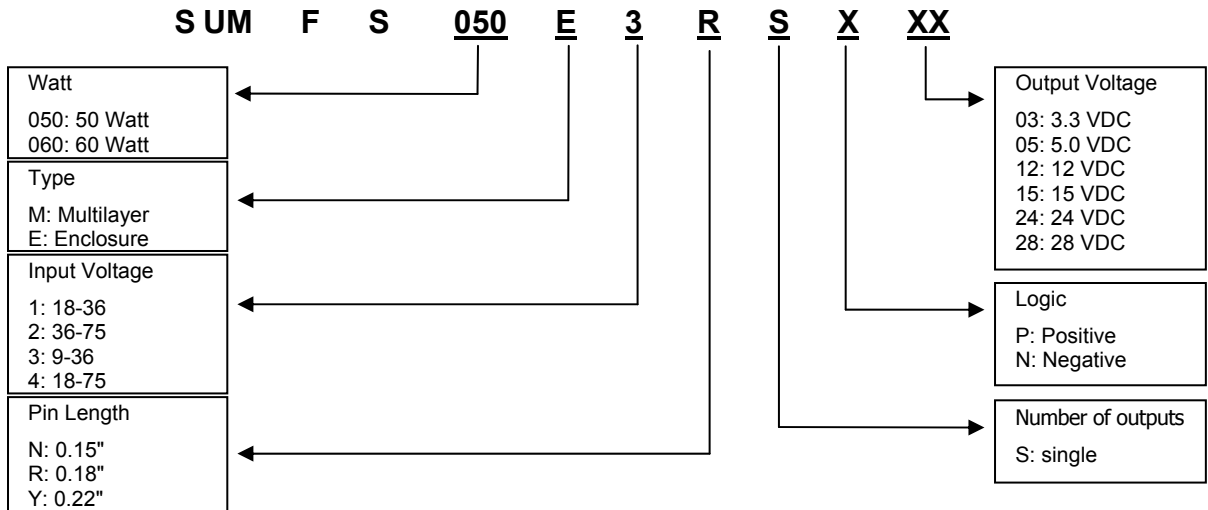

ORDERING INFORMATION

When ordering SCHMID-M converter, Please ensure that you use the complete 14 character part number consisting of the 4 character base part number and the additional 10 characters for option.

OUTLINE DIMENSIONS

Multilayer Type (Pin Length : 0.15")

2:1 Range

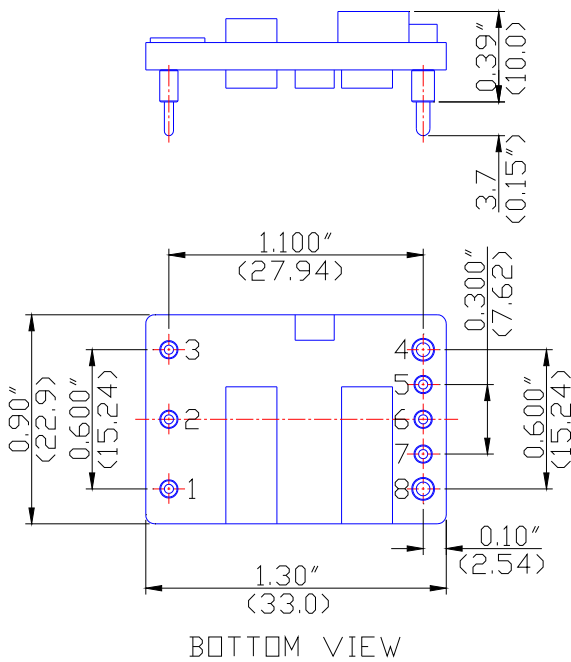

4:1 Range

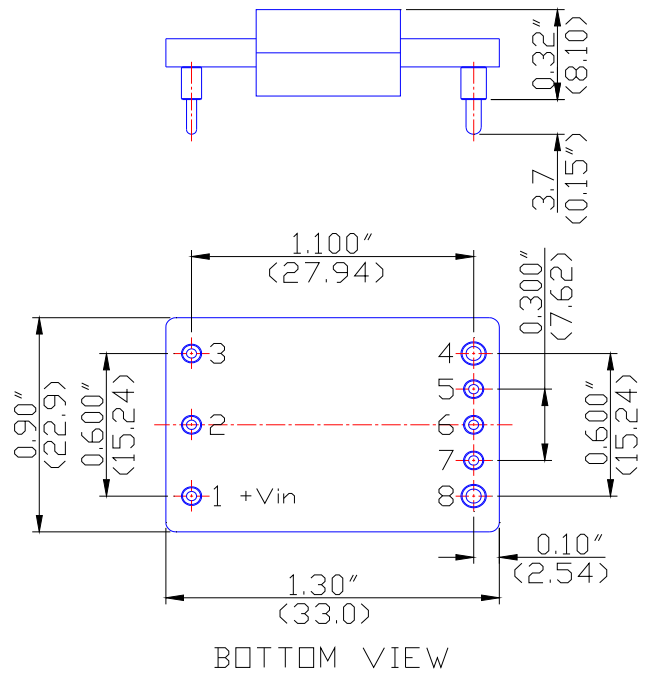

Multilayer Type(Pin Length : 0.22")

2:1 Range

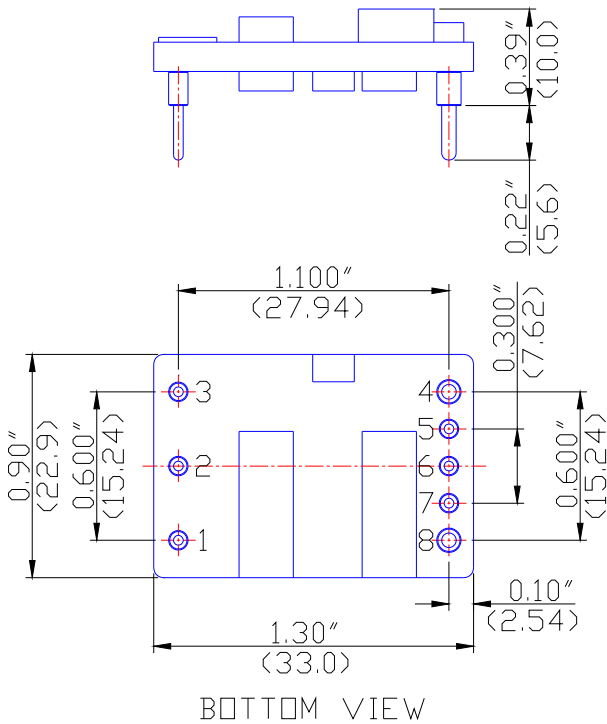

4:1 Range

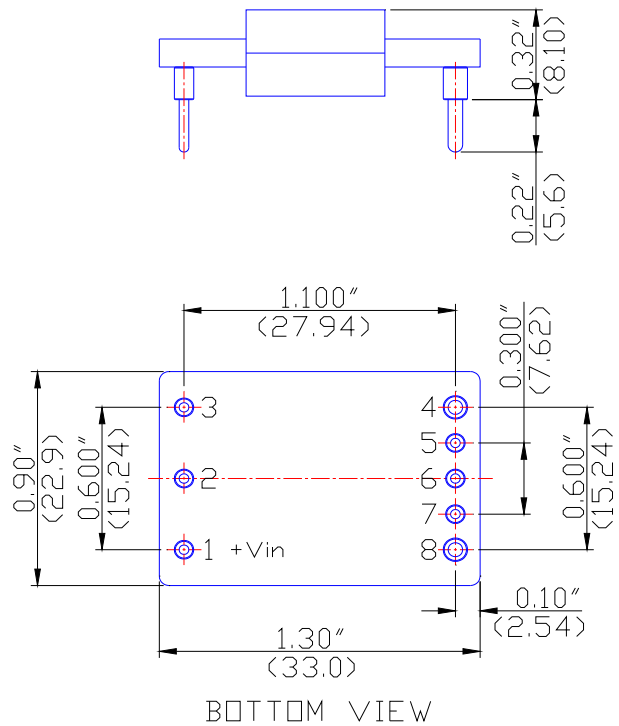

Enclosure Type (Pin Length: 0.18")

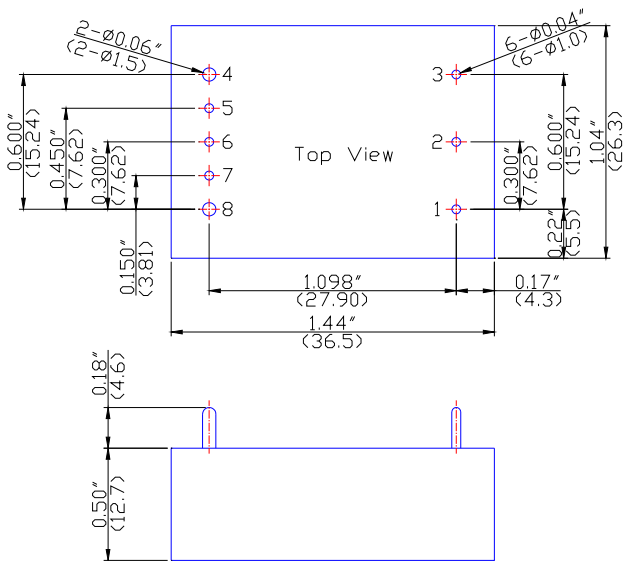

Pin Connections	
Pin	Function
1	Vin(+)
2	On/Off Control
3	Vin(-)
4	Vout(-)
5	Sense(-)
6	Trim
7	Sense(+)
8	Vout(+)

All dimensions in inches (mm).

Note 1: Pin 1,2,3,5,6,7 size is 0.04±0.005 inches (1.0 mm) dia.

Pin 4,8 size is 0.06±0.005 inches (1.5 mm) dia.

Note 2: Tolerance .xx=±0.02"
.xxx=±0.010"

Thermal Considerations

The power modules operate in a variety of thermal environments; however, sufficient cooling should be provided to help ensure reliable operation.

Considerations include ambient temperature, airflow, module power dissipation, and the need for increased reliability. A reduction in the operating temperature of the module will result in an increase in reliability. The thermal data presented here is based on physical measurements taken in a wind tunnel.

The thermal reference point, T_{ref} used in the specifications is shown in Figure below. For reliable operation this temperature should not exceed 110°C for Enclosure type module and 128°C for Multilayer type module, respectively. The output power of the module should not exceed the rated power for the module (V_o, set x I_o, max).

Enclosure type

Air Flow

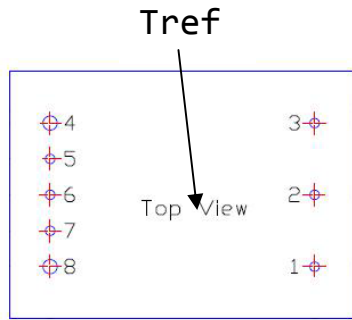

Multilayer type

Air Flow

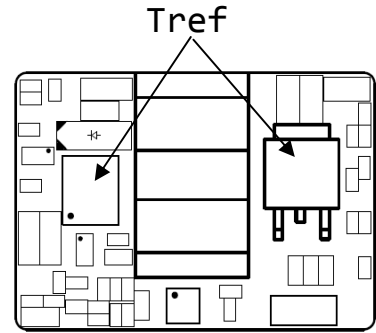

Heat Transfer via Convection

Increased airflow over the module enhances the heat transfer via convection. Derating figures showing the maximum output current that can be delivered by each module versus local ambient temperature (T_A) for natural convection and up to 2m/s (400 ft./min) are shown in the respective Characteristics Curves below. The converter is tested on a 100*100mm, 2oz, 2 layers test board mounted vertically in a wind tunnel.

Maximum Current Derating(V_{in} =Nominal 3.3V/20A) 2:1 Range

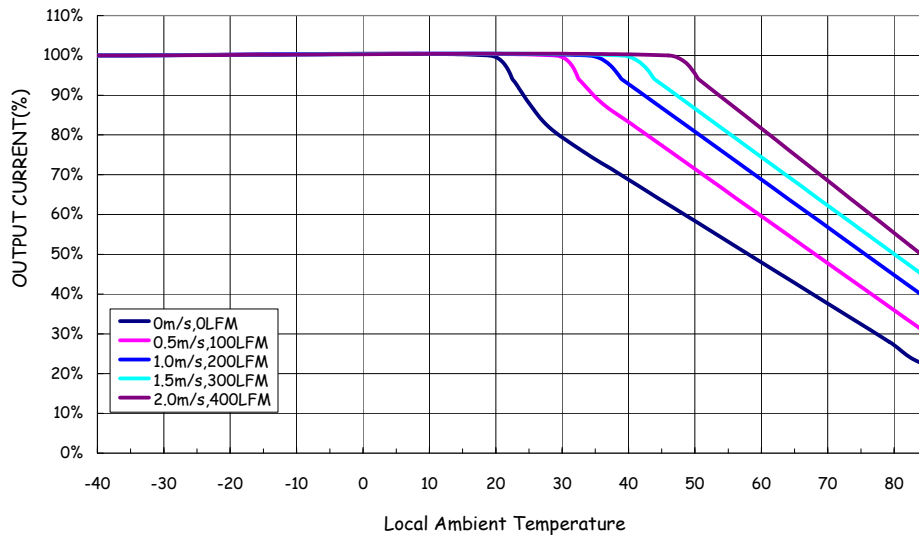

Maximum Current Derating(V_{in} =Nominal) 4:1 Range

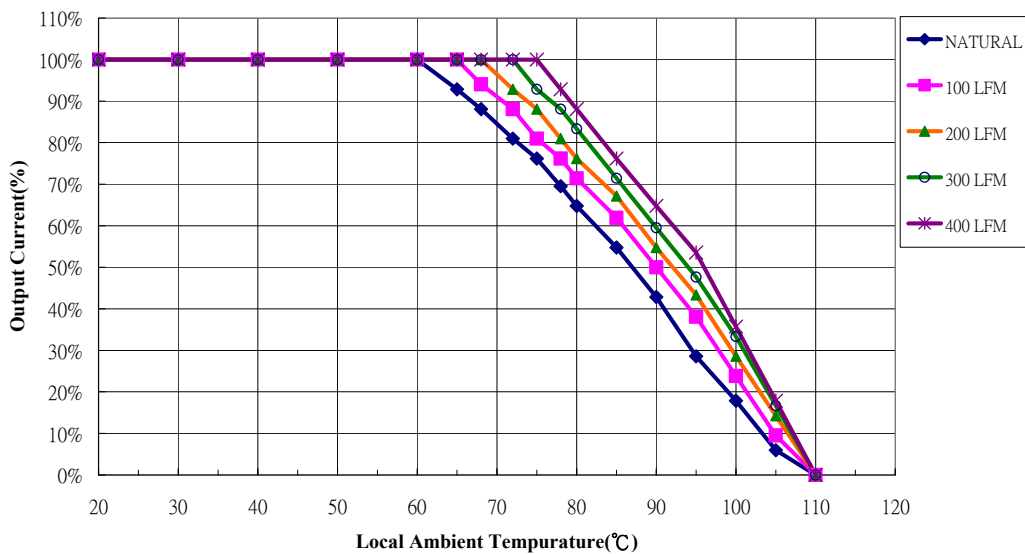

Efficiency

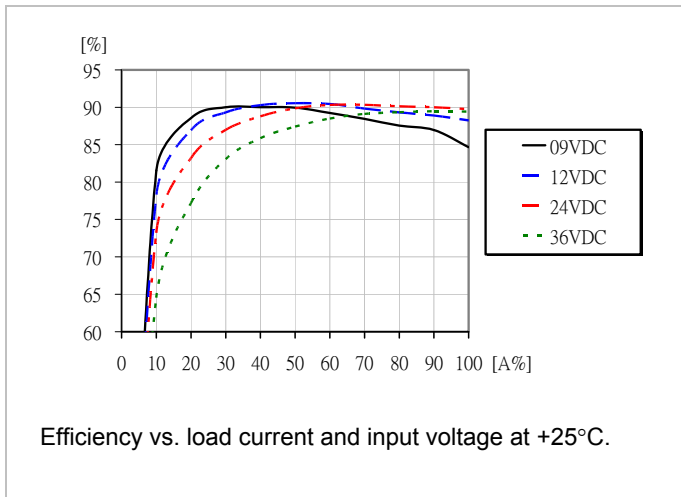

Power Dissipation

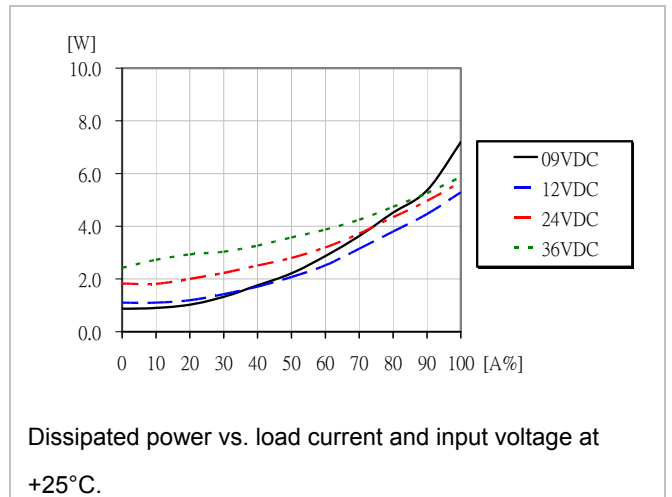

Output Characteristics

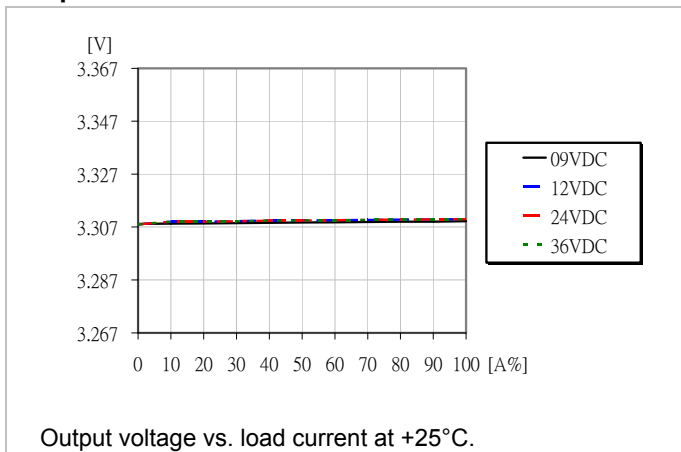

Current Limit Characteristics

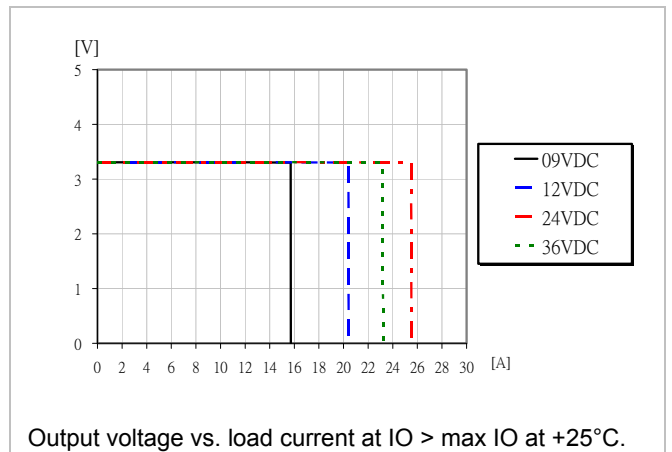

Efficiency

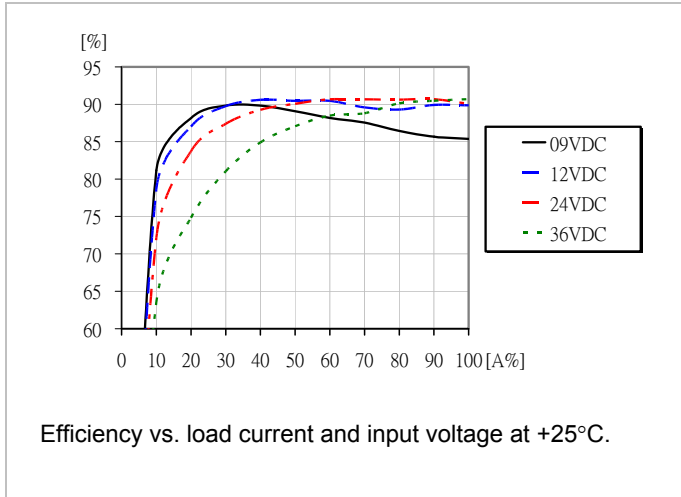

Power Dissipation

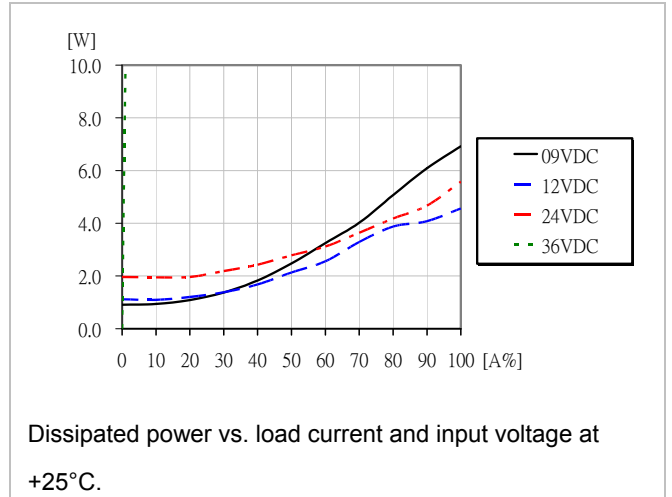

Output Characteristics

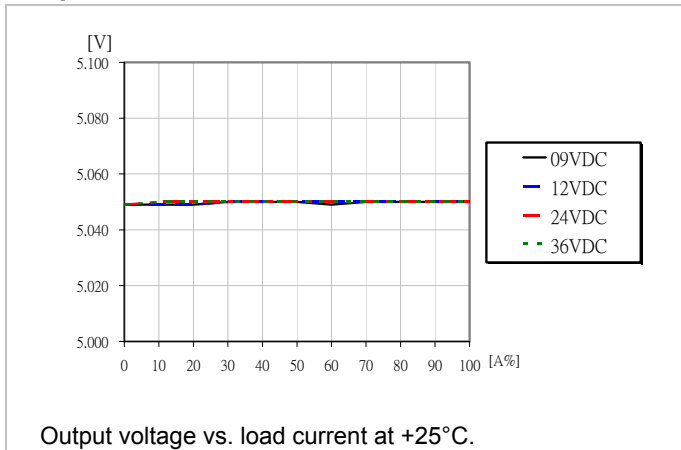

Current Limit Characteristics

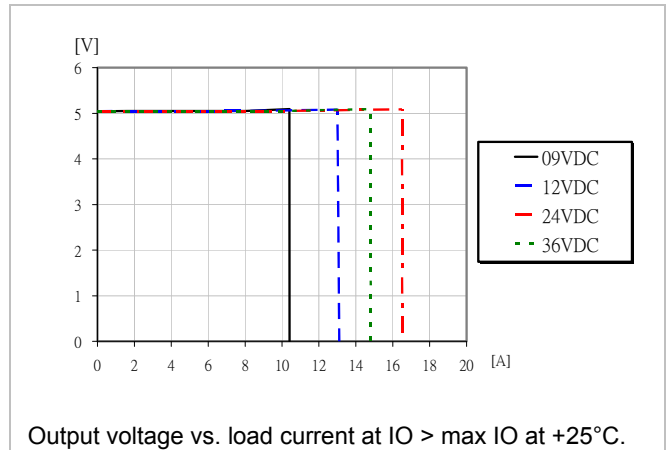

Efficiency

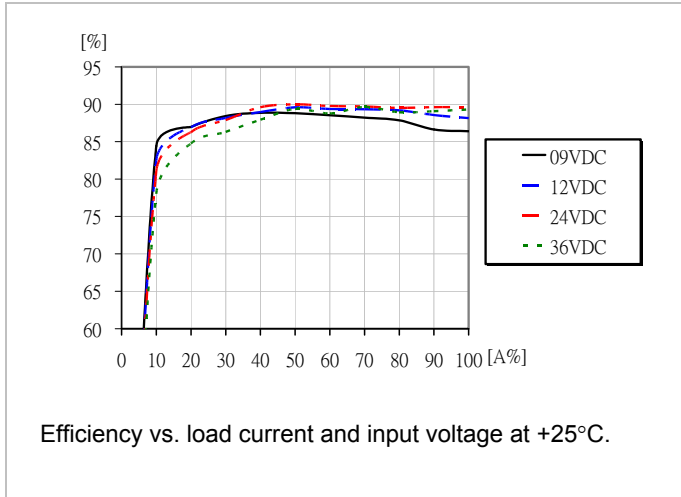

Power Dissipation

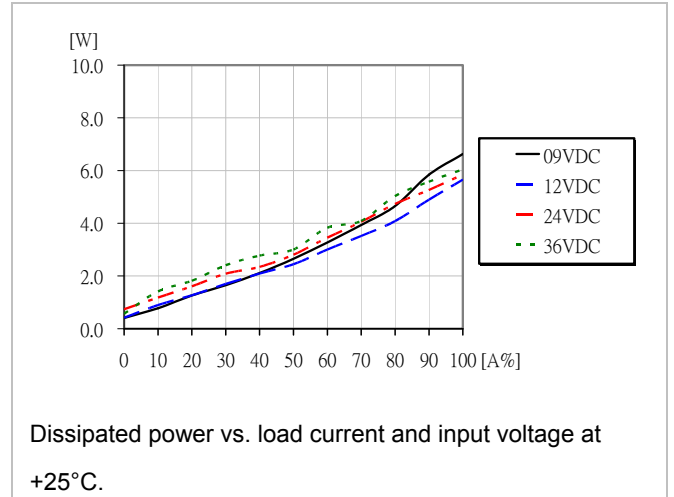

Output Characteristics

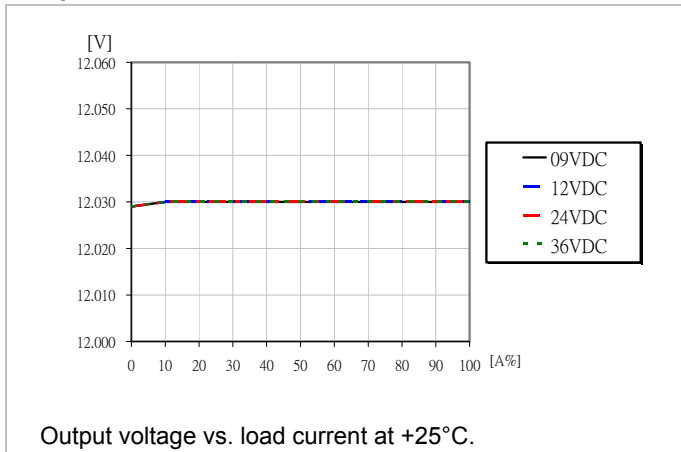

Current Limit Characteristics

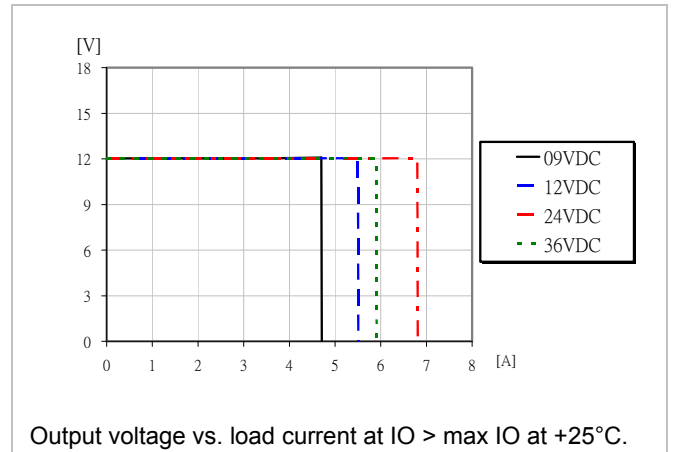

Efficiency

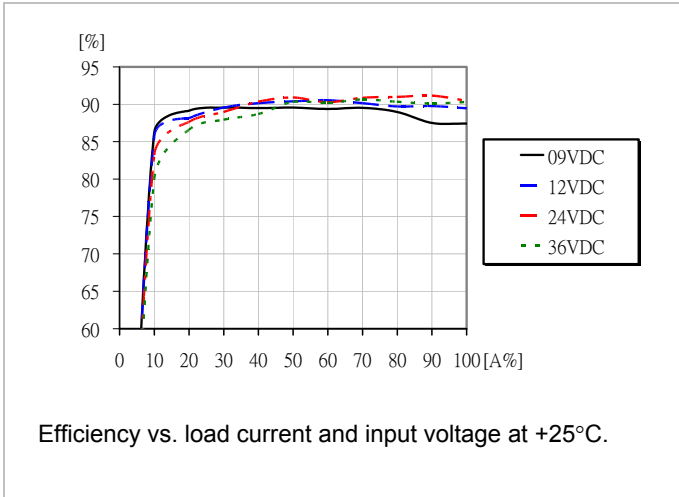

Power Dissipation

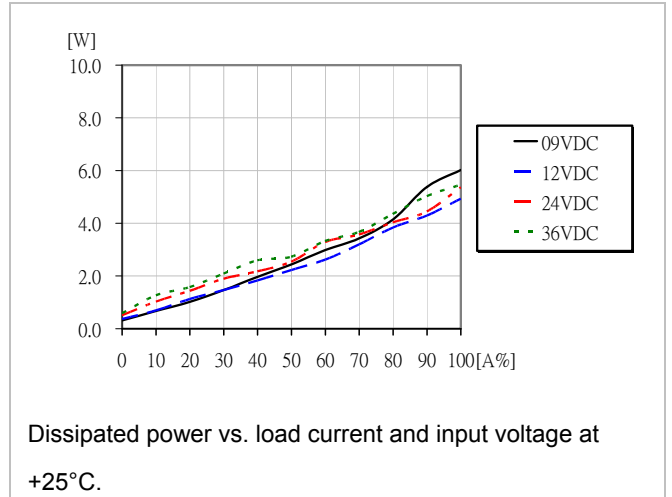

Output Characteristics

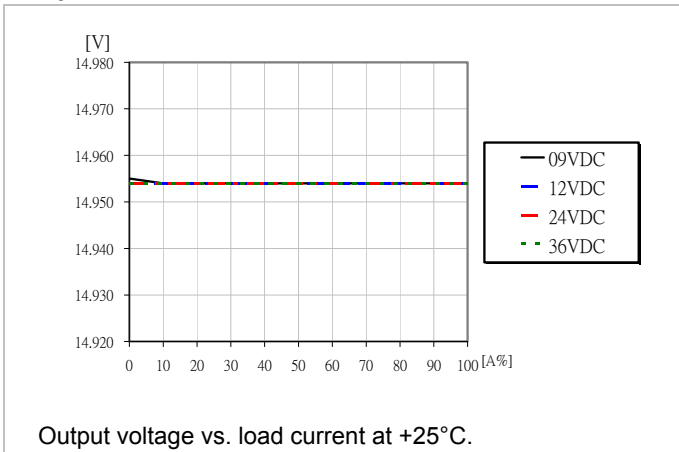

Current Limit Characteristics

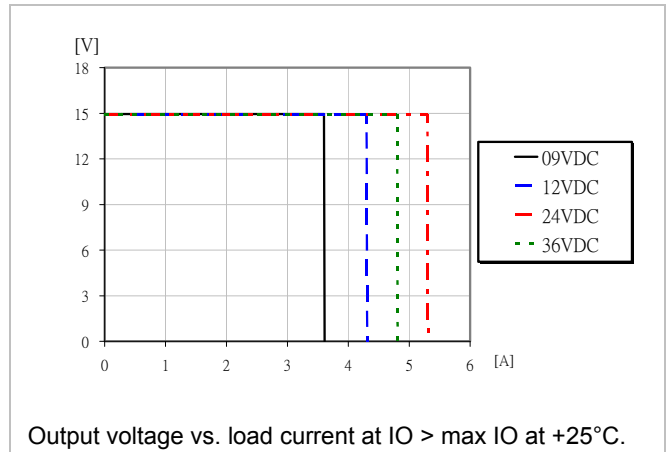

Efficiency

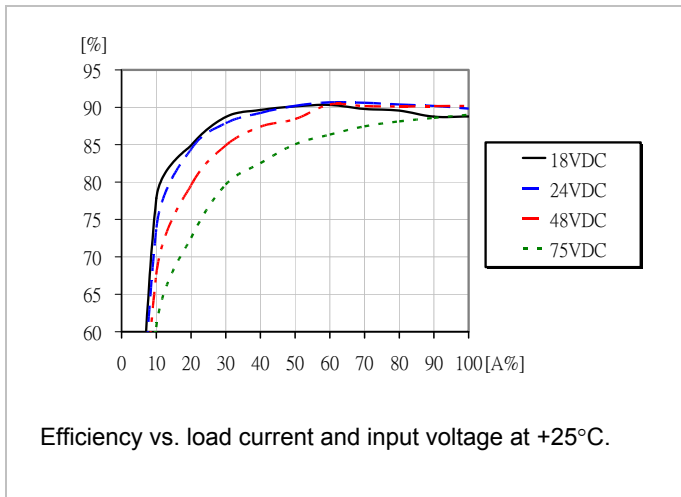

Power Dissipation

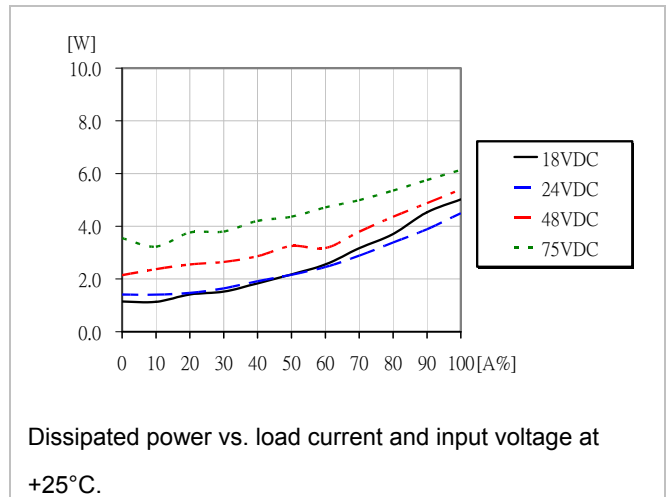

Output Characteristics

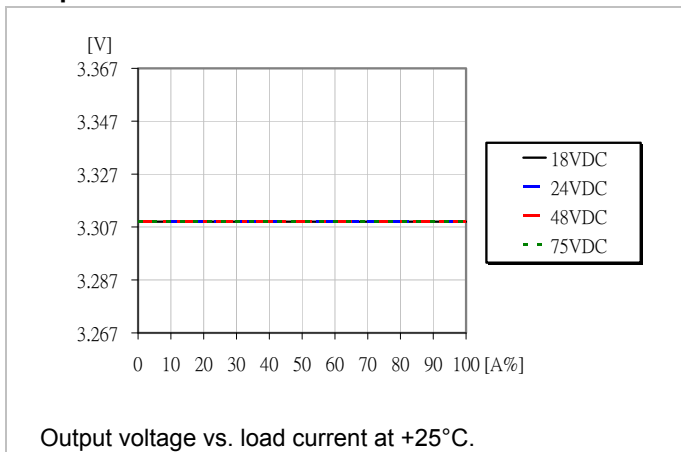

Current Limit Characteristics

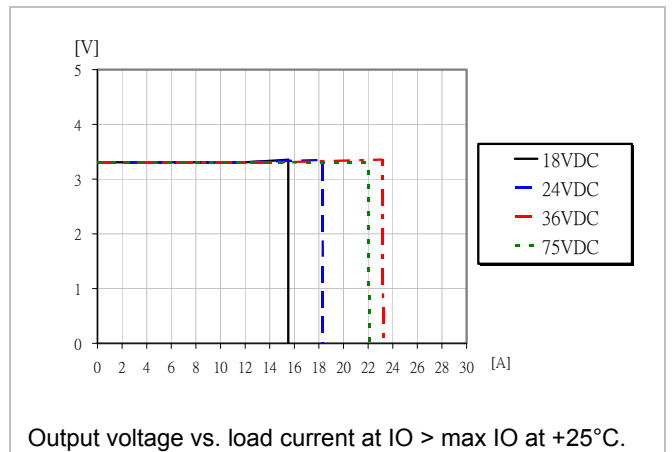

Efficiency

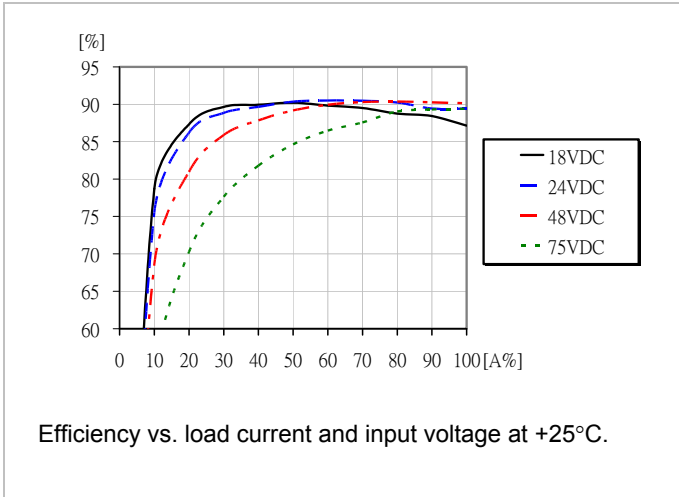

Power Dissipation

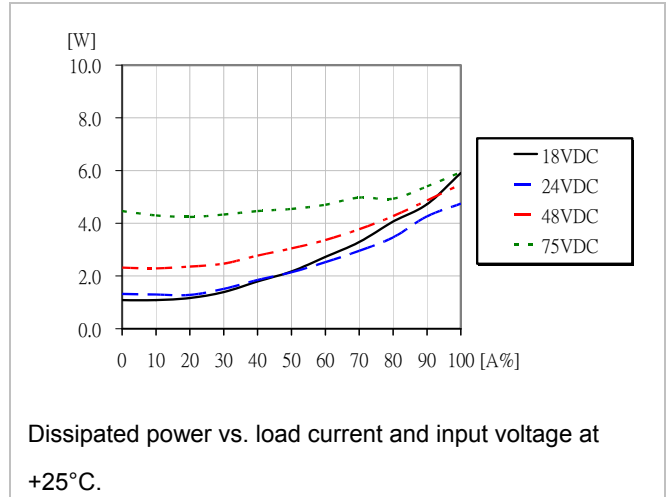

Output Characteristics

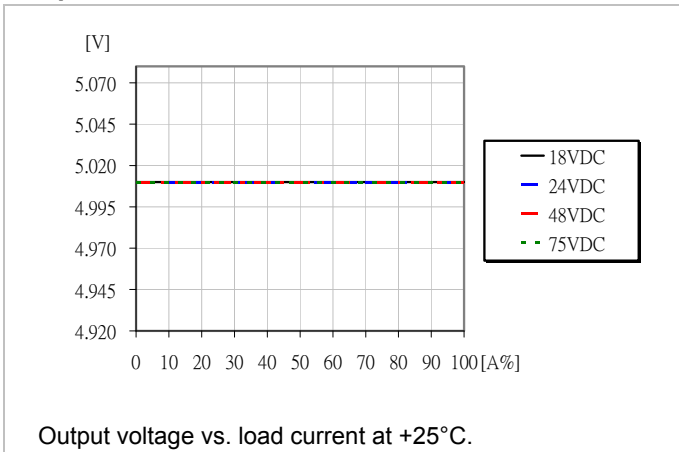

Current Limit Characteristics

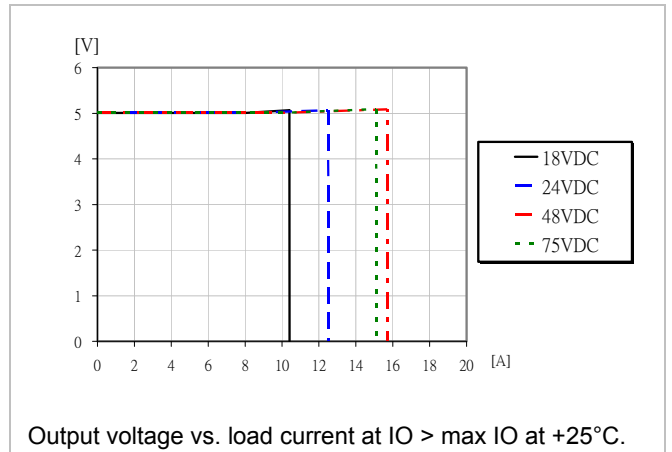

Efficiency

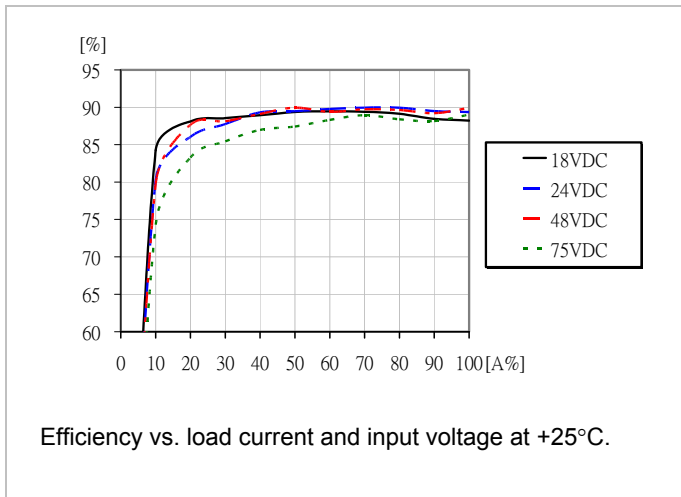

Power Dissipation

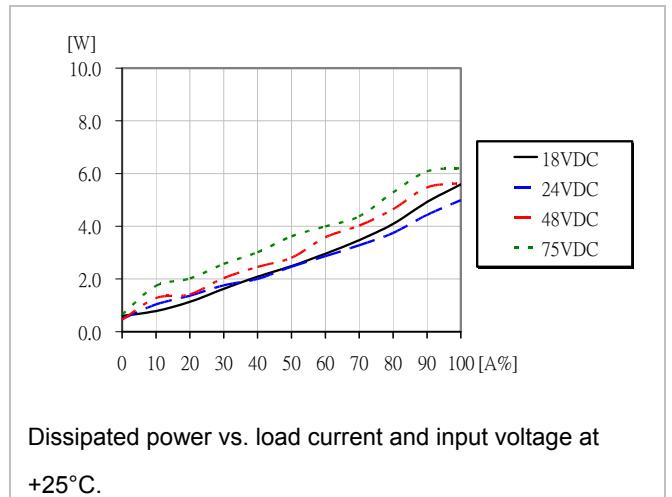

Output Characteristics

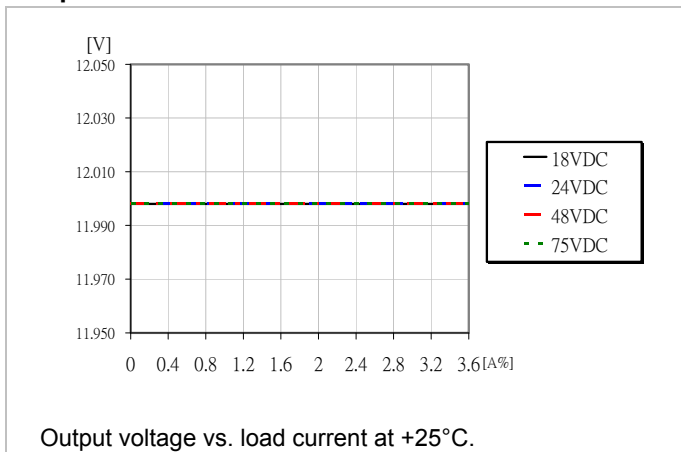

Current Limit Characteristics

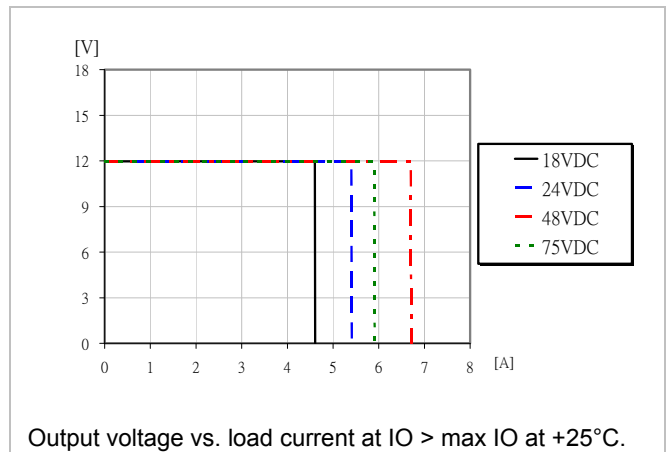

Efficiency

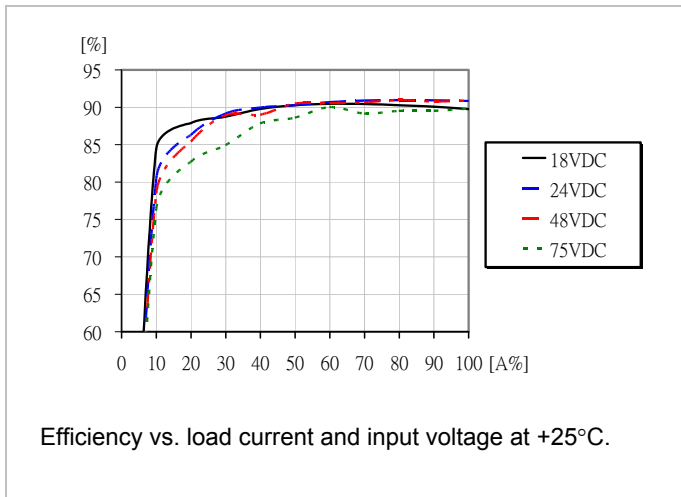

Power Dissipation

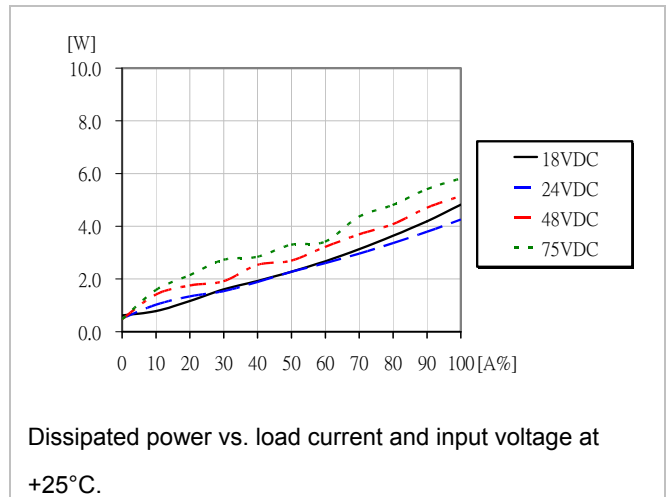

Output Characteristics

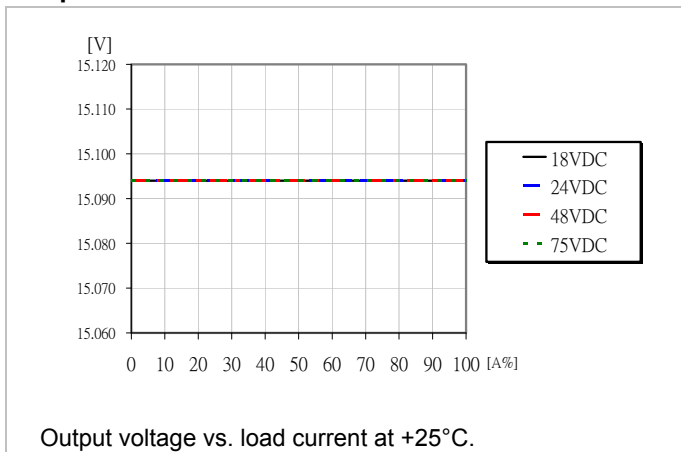

Current Limit Characteristics

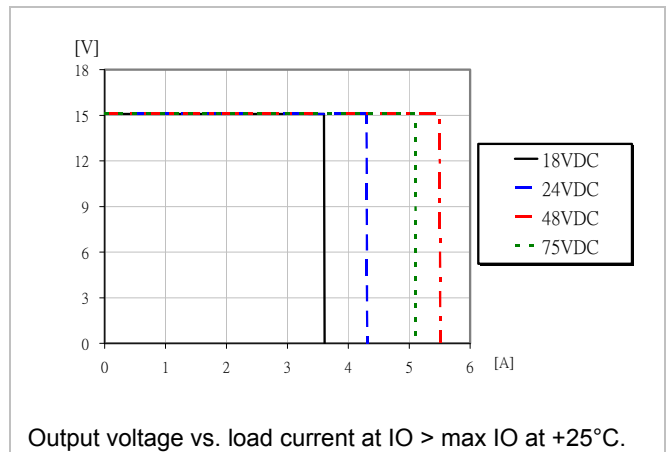

Output Voltage Adjust (TRIM UP/TRIM DOWN)

SUMFS06xExRSP0x

The resistor value for an adjusted output voltage is calculated by using the following equations:

Output Voltage Adjust, Increase:

$$R_{\text{TRIM_UP}} = \left(\frac{5.11 \times V_{o,\text{set}} \times (100 + \Delta\%)}{1.225 \times \Delta\%} - \frac{511}{\Delta\%} - 10.22 \right) \text{ k}\Omega$$

$$\Delta\% = \left(\frac{V_{\text{desired}} - V_{o,\text{set}}}{V_{o,\text{set}}} \right) \times 100$$

Output Voltage Adjust, Decrease:

$$R_{\text{TRIM_DOWN}} = \left(\frac{511}{\Delta\%} - 10.22 \right) \text{ k}\Omega$$

$$\Delta\% = \left(\frac{V_{o,\text{set}} - V_{\text{desired}}}{V_{o,\text{set}}} \right) \times 100$$

Example:

To trim up the 5.0V model by 5% to 5.25V the required external resistor is:

$$R_{\text{TRIM_UP}} = \left(\frac{5.11 \times 5.0 \times (100 + 5)}{1.225 \times 5} - \frac{511}{5} - 10.22 \right) = 325.6 \text{ k}\Omega$$

$$\Delta\% = \left(\frac{5.25 - 5.0}{5.0} \right) \times 100 = 5$$

Example:

To trim down the 3.3V model by 8% to 3.036V the required external resistor is:

$$R_{\text{TRIM_DOWN}} = \left(\frac{511}{8} - 10.22 \right) = 53.6 \text{ k}\Omega$$

$$\Delta\% = \left(\frac{3.3 - 3.036}{3.3} \right) \times 100 = 8$$