

# SB-1W Series

1W2:1 Regulated Single & Dual output

# SCHMID-M

## Features

- 8 Pin SIL / 16 Pin DIL
- Wide 2:1 Input Range
- Full SMD Technology
- 1000 VDC Isolation, Up to 3000 VDC
- Continuous Short Circuit Protection
- Efficiency up to 77%
- -40°C ~ 85°C Operation Temperature Range
- Plastic Case Standard, Optional Metal Case
- Remote on/off Control (Optional)



The SB series is a family of cost effective 1W single & dual output DC-DC converters. These converters combine non-conductive black plastic case in a 8-pin SIL / 16-pin DIL package with high performance features such as 1000Vdc~3000Vdc input/output isolation voltage, continuous short circuit protection with automatic restart and high line / load regulation. Devices are encapsulated using flame retardant resin. Input voltages of 5,12,24 and 48 with output voltage of 3.3, 5,9, 12, 15, 24, ±3.3, ±5, ±9, ±12, ±15, ±24 Vdc. High performance features include high efficiency operation up to 77% and output voltage accuracy of ±2% maximum.

All specifications typical at Ta=25°C, nominal input voltage and full load unless otherwise specified

OUTPUT SPECIFICATIONS	
Voltage Accuracy	±2%, max.
Maximun Output Current	See table, max.
Line Regulation	±0.5%, max.
Load Regulation (From 25% to 100% Loading)	±1%, max.
Cross Regulation (Dual Output) (4)	±5%
Ripple & Noise (20 Mhz bandwidth)(5)	80mVpp, max.
Short Circuit Protection	Indefinite (Automatic Recovery)
Temperature Coefficient	±0.02%/°C
Capacitive Load(6)	See table, max.

INPUT SPECIFICATIONS	
Voltage Range	See table
Input Current (No Load)	See table, max.
Input Current (Full Load)	See table, typ.
Input Filter	Capacitor
Input Reflected Ripple Current(7)	35mA pk-pk, typ.

ENVIRONMENT SPECIFICATIONS	
Operating Temperature	-40°C~85°C
Maximum Case Temperature	100°C
Storage Temperature	-40°C~125°C
Cooling	Nature Convection

ABSOLUTE MAXIMUM RATINGS(8)	
These are stress ratings. Exposure of devices to any of these conditions may adversely affect long-term reliability.	
Input Surge Voltage(100ms max.)	
05 Models	12Vdc,max.
12 Models	24Vdc,max.
24 Models	40Vdc,max.
48 Models	80Vdc,max.
Soldering Temperature (1.5mm from case 10sec max.)	260°C max.

GENERAL SPECIFICATIONS	
Efficiency	See table, typ.
I/O Isolation Voltage (60sec)	1000~3000Vdc
Metal Case/Input & Output	1000Vdc
I/O Isolation Capacitance	60 pF, max.
I/O Isolation Resistance	1000M Ohm, min.
Switching Frequency	100~650kHz
Humidity	95%reIH
Reliability Calculated MTBF(MIL-HDBK-217 F)	>1.66 Mhrs
Safety Standard :(designed to meet)	IEC/EN 60950-1
Remote On/Off (CTRL) (11)	

PHYSICAL SPECIFICATIONS	
Case Material	Non-conductive Black Plastic(UL94V-0 rated) Nickel-coated Copper
Pin Material	
SIP Case	Alloy42 Solder-coated
DIP Case	Φ0.5mm Brass Solder-coated
Potting Material	Epoxy (UL94V-0 rated)
Weight	4.5g(SIP)~6g(DIP) Metal Case/6.5g(SIP)~8g(DIP)
Dimensions	
SIP Case	0.86"x0.36"x0.44"
DIP Case	0.92"x0.55"x0.40"

EMC SPECIFICATIONS		
Radiated Emissions	EN55022	CLASS A
Conducted Emissions (12)	EN55022	CLASS A
ESD	IEC 61000-4-2	Perf. Criteria A
RS	IEC 61000-4-3	Perf. Criteria A
EFT (13)	IEC 61000-4-4	Perf. Criteria A
Surge (13)	IEC 61000-4-5	Perf. Criteria A
CS	IEC 61000-4-6	Perf. Criteria A
PFMF	IEC 61000-4-8	Perf. Criteria A

## SB-1W 2:1 Regulated Single & Dual output

### PART NUMBER STRUCTURE

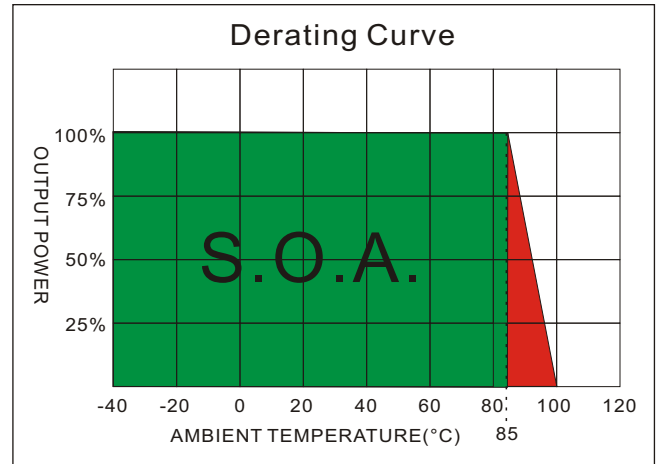
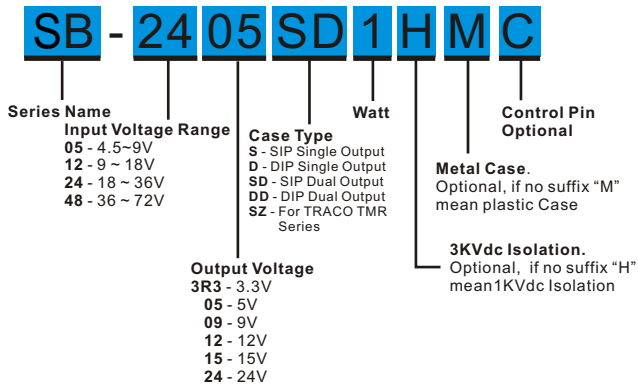

### MODEL SELECTION GUIDE

MODEL NUMBER	INPUT Voltage Range (Vdc)	INPUT Current		OUTPUT Voltage (Vdc)	OUTPUT Current		EFFICIENCY @FL (% , typ.)	Capacitor Load @FL (µF , max.)
		No-Load (mA , max.)	Full Load (mA , typ.)		Min. load (mA)	Full load (mA)		
SB-053R3S 1	4.5-9	15	298	3.3	76	303	67	3300
SB-0505S1	4.5-9	15	298	5	50	200	67	3300
SB-0509S1	4.5-9	40	285	9	28	111	70	470
SB-0512S1	4.5-9	55	285	12	21	83	70	470
SB-0515S1	4.5-9	55	285	15	17	67	70	470
SB-0524S1	4.5-9	70	294	24	10	42	68	220
SB-123R3S1	9-18	15	119	3.3	76	303	70	3300
SB-1205S1	9-18	15	115	5	50	200	72	3300
SB-1209S1	9-18	15	108	9	28	111	77	470
SB-1212S1	9-18	15	108	12	21	83	77	470
SB-1215S1	9-18	15	108	15	17	67	77	470
SB-1224S1	9-18	15	114	24	10	42	73	220
SB-243R3S 1	18-36	8	59	3.3	76	303	70	3300
SB-2405S1	18-36	8	57	5	50	200	72	3300
SB-2409S1	18-36	8	55	9	28	111	75	470
SB-2412S1	18-36	8	55	12	21	83	75	470
SB-2415S1	18-36	8	55	15	17	67	75	470
SB-2424S1	18-36	8	55	24	10	42	75	220
SB-483R3S 1	36-72	6	31	3.3	76	303	66	3300
SB-4805S1	36-72	6	30	5	50	200	68	3300
SB-4809S1	36-72	6	29	9	28	111	70	470
SB-4812S1	36-72	6	29	12	21	83	70	470
SB-4815S1	36-72	6	29	15	17	67	70	470
SB-4824S1	36-72	6	30	24	10	42	68	220
SB-053R3D1	4.5-9	15	298	3.3	76	303	67	3300
SB-0505D1	4.5-9	15	298	5	50	200	67	3300
SB-0509D1	4.5-9	40	285	9	28	111	70	470
SB-0512D1	4.5-9	55	285	12	21	83	70	470
SB-0515D1	4.5-9	55	285	15	17	67	70	470
SB-0524D1	4.5-9	70	294	24	10	42	68	220
SB-123R3D1	9-18	15	119	3.3	76	303	70	3300
SB-1205D1	9-18	15	115	5	50	200	72	3300
SB-1209D1	9-18	15	108	9	28	111	77	470
SB-1212D1	9-18	15	108	12	21	83	77	470
SB-1215D1	9-18	15	108	15	17	67	77	470
SB-1224D1	9-18	15	114	24	10	42	73	220

*SB-1W 2:1 Regulated Single & Dual output*

**MODEL SELECTION GUIDE**

MODEL NUMBER	INPUT Voltage Range (Vdc)	INPUT Current		OUTPUT Voltage (Vdc)	OUTPUT Current		EFFICIENCY @FL (% typ.)	Capacitor Load @FL (µF max.)
		No-Load (mA max.)	Full Load (mA typ.)		Min. load (mA)	Full load (mA)		
SB-243R3D1	18-36	8	59	3.3	76	303	70	3300
SB-2405D1	18-36	8	57	5	50	200	72	3300
SB-2409D1	18-36	8	55	9	28	111	75	470
SB-2412D1	18-36	8	55	12	21	83	75	470
SB-2415D1	18-36	8	55	15	17	67	75	470
SB-2424D1	18-36	8	55	24	10	42	75	220
SB-483R3D1	36-72	6	31	3.3	76	303	66	3300
SB-4805D1	36-72	6	30	5	50	200	68	3300
SB-4809D1	36-72	6	29	9	28	111	70	470
SB-4812D1	36-72	6	29	12	21	83	70	470
SB-4815D1	36-72	6	29	15	17	67	70	470
SB-4824D1	36-72	6	30	24	10	42	68	220
SB-053R3SD1	4.5-9	15	285	±3.3	±38	±152	70	±1000
SB-0505SD1	4.5-9	15	270	±5	±25	±100	74	±1000
SB-0509SD1	4.5-9	20	270	±9	±14	±56	74	±220
SB-0512SD1	4.5-9	20	266	±12	±10	±42	75	±220
SB-0515SD1	4.5-9	40	285	±15	±8	±33	70	±220
SB-0524SD1	4.5-9	70	298	±24	±5	±21	67	±100
SB-123R3SD1	9-18	15	119	±3.3	±38	±152	70	±1000
SB-1205SD1	9-18	15	115	±5	±25	±100	72	±1000
SB-1209SD1	9-18	15	109	±9	±14	±56	76	±220
SB-1212SD1	9-18	15	109	±12	±10	±42	76	±220
SB-1215SD1	9-18	15	112	±15	±8	±33	74	±220
SB-1224SD1	9-18	40	124	±24	±5	±21	67	±100
SB-243R3SD1	18-36	8	59	±3.3	±38	±152	70	±1000
SB-2405SD1	18-36	8	59	±5	±25	±100	70	±1000
SB-2409SD1	18-36	8	54	±9	±14	±56	76	±220
SB-2412SD1	18-36	8	54	±12	±10	±42	77	±220
SB-2415SD1	18-36	8	55	±15	±8	±33	75	±220
SB-2424SD1	18-36	20	59	±24	±5	±21	70	±100
SB-483R3SD1	36-72	6	30	±3.3	±38	±152	70	±1000
SB-4805SD1	36-72	6	30	±5	±25	±100	70	±1000
SB-4809SD1	36-72	6	28	±9	±14	±56	74	±220
SB-4812SD1	36-72	6	27	±12	±10	±42	76	±220
SB-4815SD1	36-72	6	29	±15	±8	±33	72	±220
SB-4824SD1	36-72	12	30	±24	±5	±21	70	±100
SB-053R3DD1	4.5-9	15	285	±3.3	±38	±152	70	±1000
SB-0505DD1	4.5-9	15	270	±5	±25	±100	74	±1000
SB-0509DD1	4.5-9	20	270	±9	±14	±56	74	±220
SB-0512DD1	4.5-9	20	266	±12	±10	±42	75	±220
SB-0515DD1	4.5-9	40	285	±15	±8	±33	70	±220
SB-0524DD1	4.5-9	70	298	±24	±5	±21	67	±100
SB-123R3DD1	9-18	15	119	±3.3	±38	±152	70	±1000
SB-1205DD1	9-18	15	115	±5	±25	±100	72	±1000
SB-1209DD1	9-18	15	109	±9	±14	±56	76	±220
SB-1212DD1	9-18	15	109	±12	±10	±42	76	±220
SB-1215DD1	9-18	15	112	±15	±8	±33	74	±220
SB-1224DD1	9-18	40	124	±24	±5	±21	67	±100
SB-243R3DD1	18-36	8	59	±3.3	±38	±152	70	±1000
SB-2405DD1	18-36	8	59	±5	±25	±100	70	±1000

**SB-1W 2:1 Regulated Single & Dual output**

**MODEL SELECTION GUIDE**

MODEL NUMBER	INPUT Voltage Range (Vdc)	INPUT Current		OUTPUT Voltage (Vdc)	OUTPUT Current		EFFICIENCY @FL (% , typ.)	Capacitor Load @FL (μF, max.)
		No-Load (mA, max.)	Full Load (mA, typ.)		Min. load (mA)	Full load (mA)		
SB-2409DD1	18-36	8	54	±9	±14	±56	76	±220
SB-2412DD1	18-36	8	54	±12	±10	±42	77	±220
SB-2415DD1	18-36	8	55	±15	±8	±33	75	±220
SB-2424DD1	18-36	20	59	±24	±5	±21	70	±100
SB-483R3DD1	36-72	6	30	±3.3	±38	±152	70	±1000
SB-4805DD1	36-72	6	30	±5	±25	±100	70	±1000
SB-4809DD1	36-72	6	28	±9	±14	±56	74	±220
SB-4812DD1	36-72	6	27	±12	±10	±42	76	±220
SB-4815DD1	36-72	6	29	±15	±8	±33	72	±220
SB-4824DD1	36-72	12	30	±24	±5	±21	70	±100

Suffix "H" means 3KVdc isolation

Suffix "C" means with control pin

Suffix "M" means with Metal Case

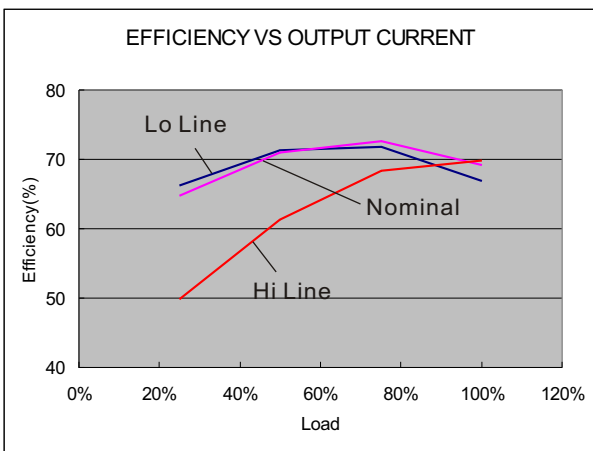

05 Models

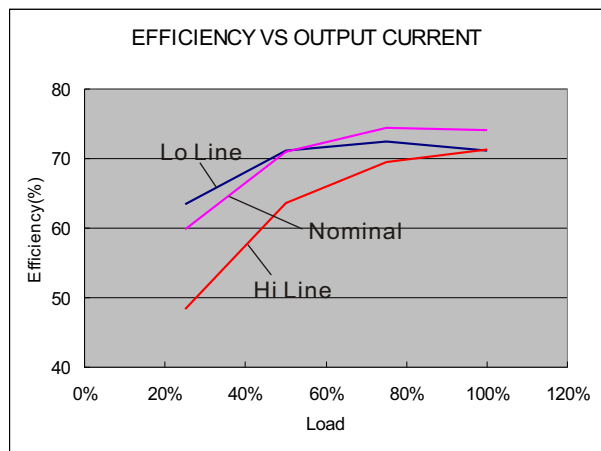

12 Models

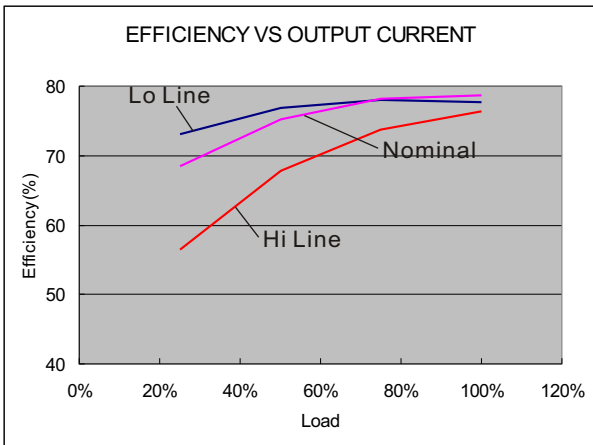

24 Models

**NOTE**

1. Maximum value at nominal input voltage and full load.
2. Typical value at nominal input voltage and full load.
3. 25% minimum loading is needed.
4. One load is 25% to 100% load, the other load is 100% load, the output voltage variable rate is within ±5%.
5. Ripple/Noise measured with 20MHz bandwidth.
6. Test by nominal input voltage and constant resistor load.
7. Measured Input reflected ripple current with a simulated source inductance of 12μH.
8. Exceeding the absolute ratings of the unit could cause damage. It is not allowed for continuous operating.
9. Operation under no-load conditions will not damage these devices, however they may not meet all listed specifications.
10. It's necessary to add minimum capacitor in output for some models, please check single model datasheet for detail value.

## SB-1W 2:1 Regulated Single & Dual output

### NOTE

#### 11. MCU (Master Control Unit)

The MCU Pin Voltage is referenced to -Vin(Pin 1)

ON:0 ~ 0.8VDC Max.

(Short circuit Pin 1 and Pin 3) or open circuit

OFF:4.5 to 15VDC Max.(or 3.5mA to 15mA Max.)(via R1,D1)

OFF idle current:5mA typ.

#### Connection example



12. Input filter components are required to help meet conducted emission class A, which application refer to the EMI Filter of design & test configuration.

13. An external filter capacitor is required if the module has to meet IEC61000-4-4 and IEC61000-4-5.

The filter capacitor SCHMID-M suggest: Nippon - chemi - con KY series, 220 $\mu$ F/100V.

### TEST CONFIGURATIONS

#### Input Reflected Ripple Current Test Step

Input reflected ripple current is measured through a source inductor  $L_{in}$ (12 $\mu$ H) and a source capacitor  $C_{in}$ (47 $\mu$ F, ESR<1.0 $\Omega$  at 100KHz) at nominal input and full load.

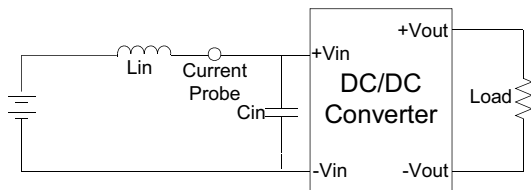

#### Output Ripple & Noise Measurement Test

The Scope measurement bandwidth is 20MHz.

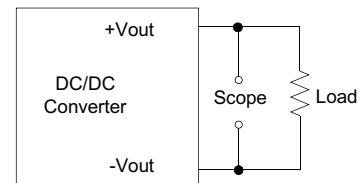

#### EMI Filter

Input filter components ( $C_1$ ,  $L$ ) are used to help meet conducted emissions requirement for the module. These components should be mounted as close as possible to the module; and all leads should be minimized to decrease radiated noise.

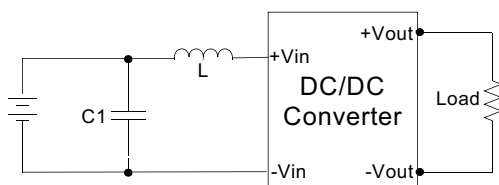

	C1	L
SB-1W&2W-Series	100 $\mu$ F/100V	12 $\mu$ H

**MECHANICAL SPECIFICATIONS**

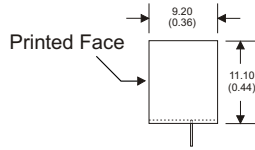
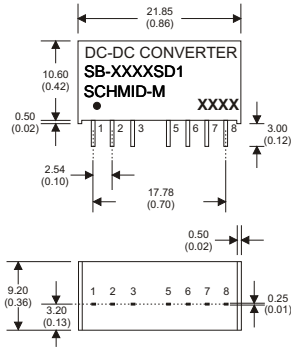

**8 Pin SIL Package**  
Non-Conductive Plastic

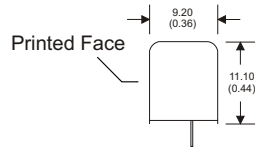
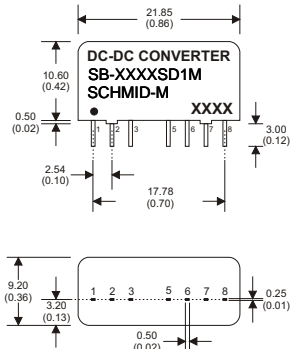

**8 Pin SIL Package**  
Nickel-Coated Copper

Notes: All dimensions are typical in millimeters ( inches ).  
 1. Pin diameter: 0.5 ±0.05 ( 0.02 ±0.002 )  
 2. Pin pitch and length tolerance: ±0.35 ( ±0.014 )  
 3. Case Tolerance: ±0.5 ( ±0.02 )

PIN CONNECTIONS			
PIN NUMBER	SINGLE	DUAL/(SD)	DUAL/(SZ)
1	-V Input	-V Input	-V Input
2	+V Input	+V Input	+V Input
3	N.P.	N.C.	N.C.
5	N.P.	N.C.	N.C.
6	+V Output	+V Output	+V Output
7	-V Output	-V Output	Common
8	N.C.	Common	-V Output
PIN NUMBER	SINGLE+C	DUAL/(SD+C)	DUAL/(SZ+C)
1	-V Input	-V Input	-V Input
2	+V Input	+V Input	+V Input
3	Remote On/Off	Remote On/Off	Remote On/Off
5	N.C.	N.C.	N.C.
6	+V Output	+V Output	+V Output
7	-V Output	-V Output	Common
8	N.C.	Common	-V Output

(The Pin Connection of high isolation one is the same with normal one.)

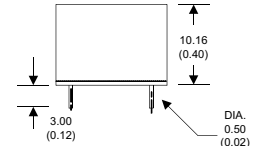
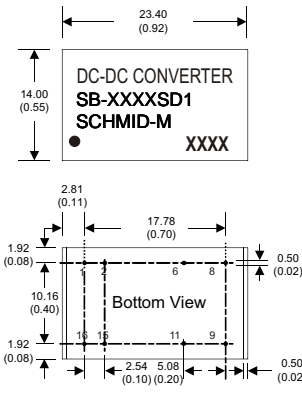

**16 Pin DIL Package**  
Non-Conductive Plastic

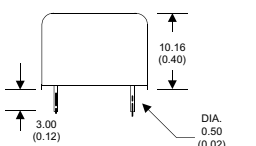
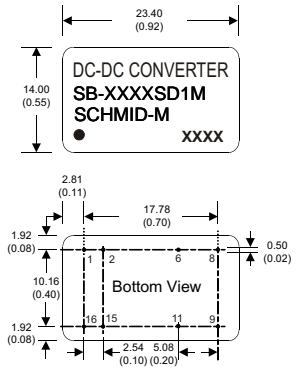

**16 Pin DIL Package**  
Nickel-Coated Copper

PIN CONNECTIONS		
PIN NUMBER	SINGLE	DUAL
1	-V Input	-V Input
2	-V Input	-V Input
6	N.C.	Common
8	N.C.	-V Output
9	+V Output	+V Output
11	-V Output	Common
15	+V Input	+V Input
16	+V Input	+V Input

(The Pin Connection of high isolation one is the same with normal one.)