

# SA-1W Series

1W Unregulated Single output

# SCHMID-M

## Features

- 4 Pin SIL / 8 Pin DIL Package
- 1000 VDC Isolation
- Up to 3000 VDC Isolation
- Low Ripple and Noise
- Efficiency up to 83%
- -40 ~ 85°C Operation Temperature Range
- Non-Conductive Black Plastic Case
- EMI Complies With EN55022 Class B



The SA series is a family of cost effective 1W single output DC-DC converters. These converters achieve low cost and ultra-miniature SIP 4 pin or DIP 8 pin size. Devices are encapsulated using flame retardant resin. The models operate from input voltage of 3.3, 5, 12, 15, 24, 48 Vdc with output voltage of 3.3, 5, 7.2, 9, 12, 15, 18, 24 Vdc. High performance features include 1000Vdc~3000Vdc input/output isolation, high efficiency operation and output voltage accuracy of  $\pm 3\%$  maximum. Standard features include an input range of  $\pm 10\%$  tolerance and low output noise and ripple.

All specifications typical at  $T_a=25^\circ\text{C}$ , nominal input voltage and full load unless otherwise specified

OUTPUT SPECIFICATIONS	
Voltage accuracy	$\pm 3\%$
Line regulation	$\pm 1.2\%$ / Per 1% Vin Change
Load regulation	(From 20% to 100% Load) $\pm 10\%$ (Output 3.3V Model) $\pm 20\%$
Ripple & noise(20 MHz bandwidth)(1)	100mV pk-pk
Temperature coefficient	$\pm 0.02\%/^\circ\text{C}$
Capacitor load(2)	See table

INPUT SPECIFICATIONS	
Voltage Range	$\pm 10\%$
Max. Input Current	See table
No-Load Input Current	See table
Input Filter	Capacitors
Input Reflected Ripple Current(3)	20mA pk-pk

ENVIRONMENT SPECIFICATIONS	
Operating Temperature	$-40^\circ\text{C} \sim 85^\circ\text{C}$ (See Derating Curve)
Maximum Case Temperature	100°C
Storage Temperature	$-40^\circ\text{C} \sim 125^\circ\text{C}$
Cooling	Nature Convection

GENERAL SPECIFICATIONS	
Efficiency	See table
I/O Isolation Voltage(3 sec)	
Input/Output	1000~3000Vdc
I/O Isolation Capacitance	60 pF Typ.
I/O Isolation Resistance	1000M Ohm
Switching Frequency	Variable 80kHz
Humidity	95% rel H
Reliability Calculated MTBF(MIL-HDBK-217 F)	> 1.121Mhrs
Safety Standard : (designed to meet)	IEC 60950-1

PHYSICAL SPECIFICATIONS	
Case Material	Non-conductive Black Plastic(UL94V-0 rated)
Pin Material	
SIP Case	0.5mm Alloy42 Solder-coated
DIP Case	$\varnothing 0.5\text{mm}$ Brass Solder-coated
Potting Material	Epoxy (UL94V-0 rated)
Weight	(SIP/1.5g) (DIP/1.8g)
Dimensions	SIP Case 0.46"x0.24"x0.40" DIP Case 0.50"x0.40"x0.27"

ABSOLUTE MAXIMUM RATINGS(4)	
These are stress ratings. Exposure of devices to any of these conditions may adversely affect long-term reliability.	
Input Surge Voltage(100mS)	
3.3 Models	6 Vdc ,max.
5 Models	7 Vdc ,max.
12 Models	15 Vdc ,max.
15 Models	18 Vdc ,max.
24 Models	28 Vdc ,max.
48 Models(for SIP)	54 Vdc ,max.
Soldering Temperature (1.5mm from case 10sec. max.)	260°C ,max.

EMC SPECIFICATIONS		
Radiated Emissions	EN55022	CLASS B
Conducted Emissions (6)	EN55022	CLASS B
ESD	IEC 61000-4-2	Perf. Criteria A
RS	IEC 61000-4-3	Perf. Criteria A
EFT (7)	IEC 61000-4-4	Perf. Criteria A
Surge (7)	IEC 61000-4-5	Perf. Criteria A
CS	IEC 61000-4-6	Perf. Criteria A
PFMF	IEC 61000-4-8	Perf. Criteria A

## SA - 1W Unregulated Single output

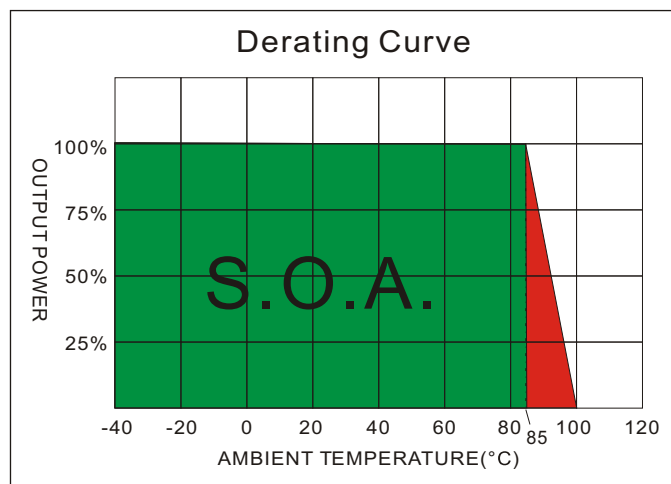
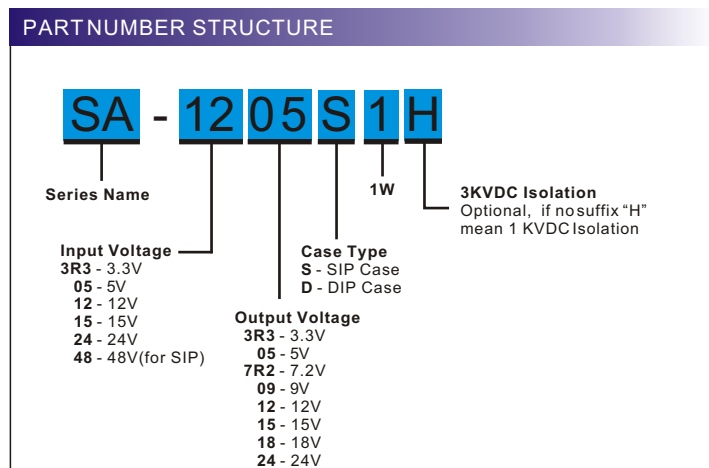

## MODEL SELECTION GUIDE

MODEL NUMBER	INPUT Voltage Range (Vdc)	INPUT Current		OUTPUT Voltage (Vdc)	OUTPUT Current Full load (mA)	EFFICIENCY @FL(%)	Capacitor Load(μF)
		No-Load (mA)	Full Load (mA)				
SA-3R33R3S1	3.3	25	421	3.3	303	72	220
SA-3R305S1	3.3	25	394	5	200	77	220
SA-3R37R2S1	3.3	25	384	7.2	139	79	220
SA-3R309S1	3.3	30	404	9	111	75	220
SA-3R312S1	3.3	45	473	12	100	77	220
SA-3R315S1	3.3	35	384	15	67	79	220
SA-3R318S1	3.3	35	399	18	56	76	220
SA-3R324S1	3.3	53	461	24	50	79	220
SA-053R3S1	5	20	257	3.3	303	78	220
SA-0505S1	5	25	247	5	200	81	220
SA-057R2S1	5	16	241	7.2	139	83	220
SA-0509S1	5	26	250	9	111	80	220
SA-0512S1	5	25	300	12	100	80	220
SA-0515S1	5	35	244	15	67	82	220
SA-0518S1	5	25	247	18	56	81	220
SA-0524S1	5	35	289	24	50	83	220
SA-123R3S1	12	15	107	3.3	303	78	220
SA-1205S1	12	16	105	5	200	79	220
SA-127R2S1	12	16	100	7.2	139	83	220
SA-1209S1	12	15	107	9	111	78	220
SA-1212S1	12	20	125	12	100	80	220
SA-1215S1	12	15	105	15	67	79	220
SA-1218S1	12	20	104	18	56	80	220
SA-1224S1	12	25	123	24	50	81	220
SA-153R3S1	15	15	89	3.3	303	75	220
SA-1505S1	15	9	82	5	200	81	220
SA-157R2S1	15	12	88	7.2	139	76	220
SA-1509S1	15	10	90	9	111	74	220
SA-1512S1	15	13	100	12	100	80	220
SA-1515S1	15	15	84	15	67	79	220
SA-1518S1	15	12	85	18	56	78	220
SA-1524S1	15	10	99	24	50	81	220

Suffix "H" means 3 KVdcisolation

SA - 1W Unregulated Single output

MODEL NUMBER	INPUT Voltage Range (Vdc)	INPUT Current		OUTPUT Voltage (Vdc)	OUTPUT Current Full load (mA)	EFFICIENCY @FL (%)	Capacitor Load(µF)
		No-Load (mA)	Full Load (mA)				
SA-243R3S1	24	8	54	3.3	303	77	220
SA-2405 S1	24	8	52	5	200	80	220
SA-247R2S1	24	10	54	7.2	139	77	220
SA-2409 S1	24	7	54	9	111	77	220
SA-2412 S1	24	8	62	12	100	80	220
SA-2415 S1	24	8	51	15	67	81	220
SA-2418 S1	24	8	52	18	56	80	220
SA-2424 S1	24	9	60	24	50	83	220
SA-483R3S1	48	6	29	3.3	303	73	220
SA-4805 S1	48	6	28	5	200	74	220
SA-487R2S1	48	7	27	7.2	139	77	220
SA-4809 S1	48	5	27	9	111	78	220
SA-4812 S1	48	5	32	12	100	77	220
SA-4815 S1	48	5	27	15	67	76	220
SA-4818 S1	48	8	28	18	56	75	220
SA-4824 S1	48	8	31	24	50	80	220
SA-3R3 3R3D1	3.3	25	410	3.3	303	74	220
SA-3R3 05D1	3.3	25	394	5	200	77	220
SA-3R3 7R2D1	3.3	30	404	7.2	139	75	220
SA-3R3 09D1	3.3	30	399	9	111	76	220
SA-3R3 12D1	3.3	45	485	12	100	75	220
SA-3R3 15D1	3.3	25	384	15	67	79	220
SA-3R3 18S1	3.3	35	399	18	56	76	220
SA-3R3 24D1	3.3	90	485	24	50	75	220
SA-05 3R3D1	5	16	256	3.3	303	78	220
SA-05 05D1	5	15	253	5	200	79	220
SA-05 7R2D1	5	16	241	7.2	139	83	220
SA-05 09D1	5	25	253	9	111	79	220
SA-05 12D1	5	25	296	12	100	81	220
SA-05 15D1	5	25	244	15	67	82	220
SA-05 18D1	5	25	241	18	56	83	220
SA-05 24D1	5	28	293	24	50	82	220
SA-12 3R3D1	12	15	108	3.3	303	77	220
SA-12 05D1	12	16	105	5	200	79	220
SA-12 7R2D1	12	16	100	7.2	139	83	220
SA-12 09D1	12	15	105	9	111	79	220
SA-12 12D1	12	20	125	12	100	80	220
SA-12 15D1	12	17	105	15	67	79	220
SA-12 18D1	12	15	103	18	56	81	220
SA-12 24D1	12	25	127	24	50	79	220
SA-15 3R3D1	15	15	89	3.3	303	75	220
SA-15 05D1	15	10	83	5	200	80	220
SA-15 7R2D1	15	12	88	7.2	139	76	220
SA-15 09D1	15	10	85	9	111	78	220
SA-15 12D1	15	13	98	12	100	82	220
SA-15 15D1	15	15	83	15	67	80	220
SA-15 18D1	15	12	85	18	56	78	220
SA-15 24D1	15	10	99	24	50	81	220

Suffix "H" means 3 KVdc isolation

## SA - 1W Unregulated Single output

MODEL NUMBER	INPUT Voltage Range (Vdc)	INPUT Current		OUTPUT Voltage (Vdc)	OUTPUT Current Full load (mA)	EFFICIENCY @FL (%)	Capacitor Load (uF)
		No-Load (mA)	Full Load (mA)				
SA-24 3R3D1	24	8	53	3.3	303	79	220
SA-24 05D1	24	8	53	5	200	79	220
SA-24 7R2D1	24	10	56	7.2	139	74	220
SA-24 09D1	24	7	53	9	111	79	220
SA-24 12D1	24	8	63	12	100	80	220
SA-24 15D1	24	8	52	15	67	80	220
SA-24 18D1	24	8	51	18	56	82	220
SA-24 24D1	24	9	61	24	50	82	220

Suffix "H" means 3 KVdc isolation

### TEST CONFIGURATIONS

#### Input Reflected Ripple Current Test Step

Input reflected ripple current is measured through a source inductor  $L_{in}$  (12uH) and a source capacitor  $C_{in}$  (47uF, ESR < 1.0Ω at 100KHz) at nominal input and full load.

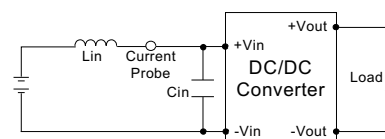

#### Output Ripple & Noise Measurement Test

The Scope measurement bandwidth is 20MHz.

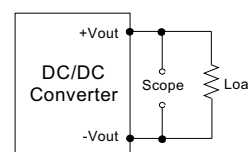

#### EMI Filter

Input filter components (C1, L, C2, C3) are used to help meet conducted emissions requirement for the module.

These components should be mounted as close as possible to the module; and all leads should be minimized to decrease radiated noise.

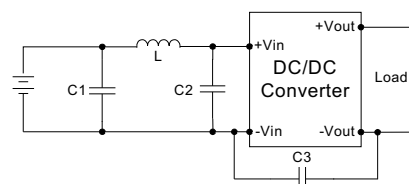

	C1	L	C2	C3
SA-3R3XXXXX	1210, 2.2uF/100V	18uH		
SA-05XXXXX	1210, 2.2uF/100V	18uH		
SA-12XXXXX	1210, 2.2uF/100V	18uH		
SA-15XXXXX	1210, 2.2uF/100V	18uH		
SA-24XXXXX	1210, 2.2uF/100V	18uH	1210, 2.2uF/100V	1206, 470pF/2KV
SA-48XXXXX	Electrolytic capacitor, 10uF/100V	18uH	1210, 2.2uF/100V	1206, 470pF/2KV

### NOTE

1. Ripple/Noise measured with 20MHz bandwidth.
2. Tested by minimal  $V_{in}$  and constant resistive load.
3. Measured Input reflected ripple current with a simulated source inductance of 12uH.
4. Exceeding the absolute ratings of the unit could cause damage. It is not allowed for continuous operating.
5. Operation under no-load conditions will not damage these devices, however they may not meet all listed specifications.
6. Input filter components are required to help meet conducted emission class B, which application refer to the EMI Filter of design & feature configuration.
7. An external filter capacitor is required if the module has to meet IEC61000-4-4 and IEC61000-4-5. The filter capacitor Schmid-M suggest: Nippon - chemi - con KY series, 470uF/100V.

# SA - 1W Unregulated Single output

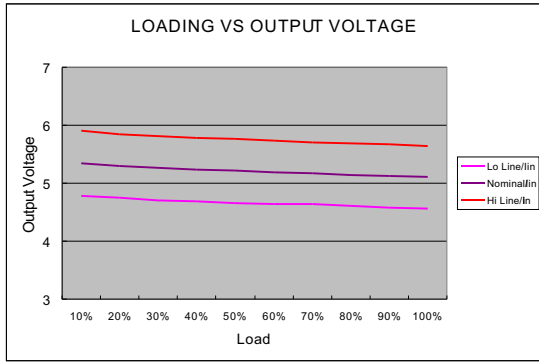

05 Models

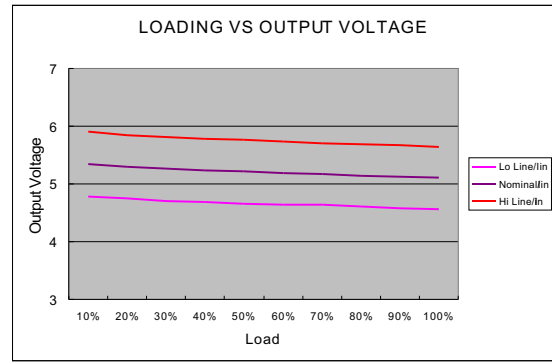

12 Models

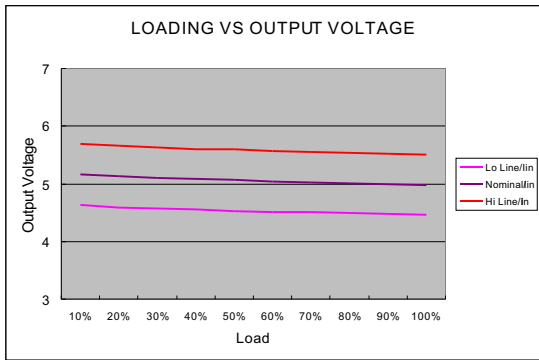

24 Models

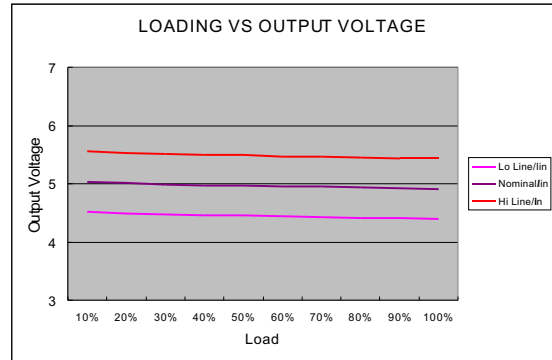

48 Models

## MECHANICAL SPECIFICATIONS

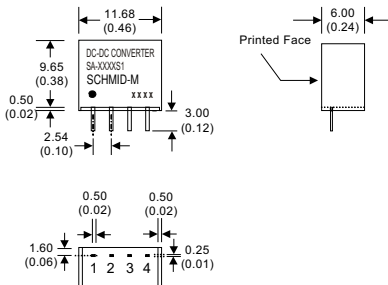

\* The thickness of 48V input voltage model is 7.50(0.29)

### 4 Pin SIL Package

- Notes : All dimensions are typical in millimeters ( inches ).
1. Pin diameter:  $0.5 \pm 0.05$  (  $0.02 \pm 0.002$  )
  2. Pin pitch and length tolerance:  $\pm 0.35$  (  $\pm 0.014$  )
  3. Case Tolerance:  $\pm 0.5$  (  $\pm 0.02$  )

### PIN CONNECTIONS

PIN NUMBER	SINGLE
1	-V Input
2	+V Input
3	-V Output
4	+V Output

(The Pin Connection of high isolation one is the same with normal one.)

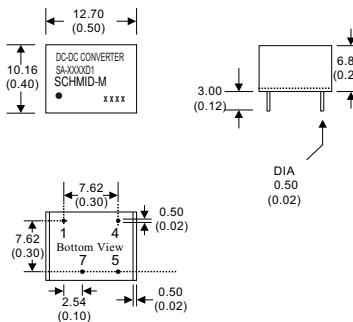

### 8 Pin DIL Package

- Notes : All dimensions are typical in millimeters ( inches ).
1. Pin diameter:  $0.5 \pm 0.05$  (  $0.02 \pm 0.002$  )
  2. Pin pitch and length tolerance:  $\pm 0.35$  (  $\pm 0.014$  )
  3. Case Tolerance:  $\pm 0.5$  (  $\pm 0.02$  )

### PIN CONNECTIONS

PIN NUMBER	SINGLE
1	-V Input
4	+V Input
5	+V Output
7	-V Output

(The Pin Connection of high isolation one is the same with normal one.)