

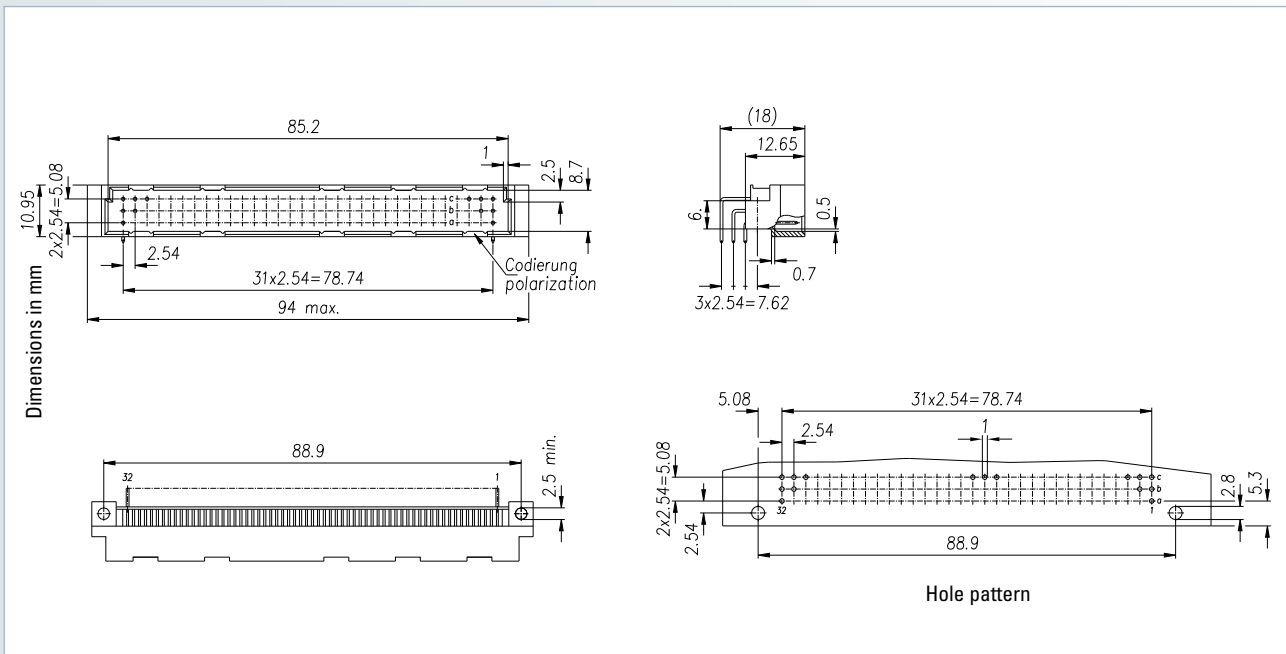

## Connectors according to DIN 41612 / IEC 60603-2

### Type C

Male connector

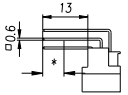
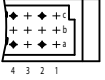
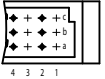
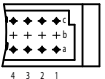
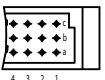

No. of contacts	Contact arrangement	Press-fit technology – Performance level II	
		Termination length	
			
Part number			
32		103-60014	103-65015
48		103-60044	103-65045
64		103-60054	103-65055
96		103-60064	103-65065

#### Accessories

- Press-fit tool (see page 206)
- Support tool (see page 207)
- Coding accessories (see page 160)

#### On request

- Performance levels I + III or customer-specific
- Special contact length

#### Options

- Contact arrangement (see page 162)

#### Note

- \* Rear mating zone performance level II

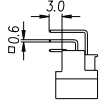
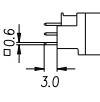
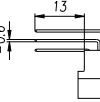
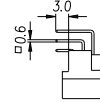
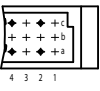
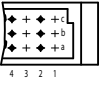
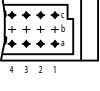
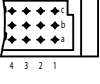

No. of contacts	Contact arrangement	Solder technology Performance level II			THTR* Performance level II
		Termination length			
					
Part number					
32		103-40014	103-40015	103-40194	103-40014TH
48		103-40024	103-40025	103-40144	103-40024TH
64		103-40034	103-40035	103-40154	103-40034TH
96		103-40064	103-40065	103-40174	103-40064TH

<p><b>Accessories</b></p> <ul style="list-style-type: none"> <li>- Coding accessories (see page 160)</li> </ul>	<p><b>On request</b></p> <ul style="list-style-type: none"> <li>- Performance levels I + III or customer-specific</li> <li>- Special contact length</li> <li>- Other termination lengths in THTR</li> </ul>	<p><b>Options</b></p> <ul style="list-style-type: none"> <li>- Board lock (see page 159)</li> <li>- Contact arrangement (see page 162)</li> </ul>
<p><b>Note</b></p> <ul style="list-style-type: none"> <li>- * THTR (Through Hole Technology Reflow)</li> </ul>		