

## Product description

### MAIN FEATURES

#### HIGH PERFORMANCE

- › Standard resolution: 16 or 32 detents
- › With or without integrated push button
- › Rotational life: Up to 1 Million revolutions
- › Up to 4.5 Ncm switching torque  
(remains consistent over lifetime)
- › Gold plated contacts
- › Robust metal housing with stainless steel or brass shaft
- › Body size: 11.5 x 12.3 x 4.9 mm
- › IP68 shaft and front panel sealing
- › Operating temperature range: -40 to +85 °C
- › Shaft electrically insulated > 500 VDC  
(shaft to contact system)
- › Various options and customizations possible

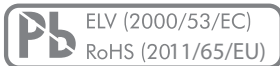

MIL-STD-202G

SWISS CLICK INDEXING SYSTEM™

(for more information see chapter «Technical explanations»)

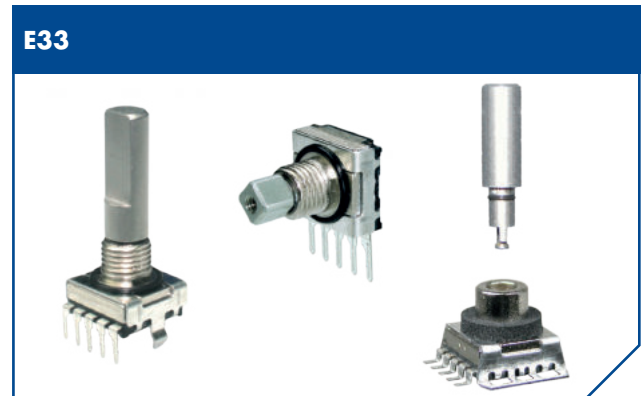

### PRODUCT VARIETY

- Vertical or horizontal mounting
- THT or SMT reflow (vacuum pick & place)
- Threaded or non-threaded bushing
- Push button force 3, 6, 10, 14 N or without push button
- Detent | pulses per revolution (PPR)  
32 / 16, 32 / 8, 16 / 16, 16 / 8
- Switching torque 0.5, 1, 1.5, 2, 2.5, 3, 3.5 or 4.5 Ncm or no detent
- Front panel sealing IP60 or IP68
- Shaft mounted, separated or without shaft
- Various standard shafts available
- Tray or tape & reel packaging

### POSSIBLE CUSTOMIZATIONS

- Shaft dimension and shape
- Stainless steel housing
- Switching torque and push button actuation force
- Indexing resolution and PPR

### TYPICAL APPLICATIONS

- Value and menu control for industrial PLCs
- Avionics, measurement and test equipment
- Frequency and channel selection for two way radios
- User interface controls for medical devices
- Volume and menu setting for transportation control and entertainment systems

## Dimensions and pin assignment

### SWITCH DESIGN

#### THT VERTICAL

Example of illustration with thread

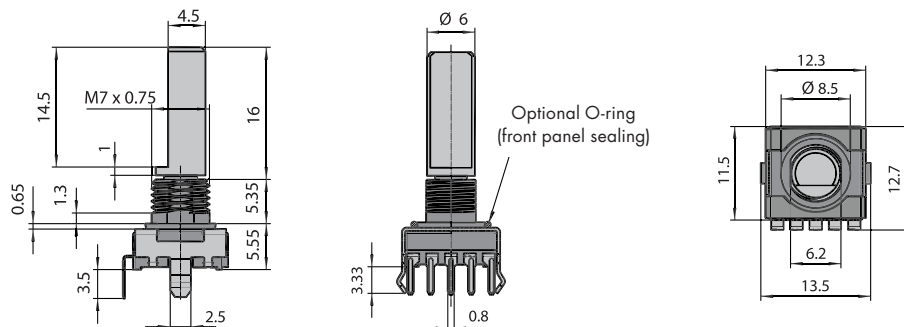

#### THT HORIZONTAL

Example of illustration with thread

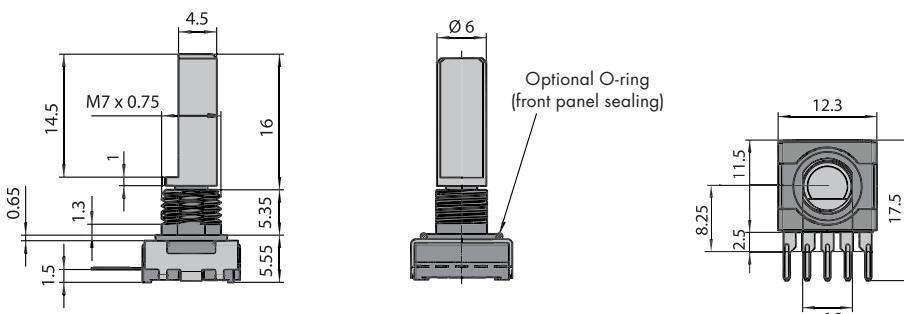

#### SMT VERTICAL

Example of illustration without thread

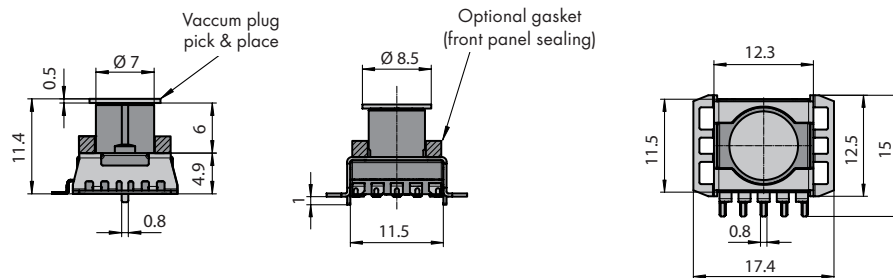

Dimensions in mm

Tolerances according to DIN ISO 2768-1 (m), unless otherwise specified

## Dimensions and pin assignment

### PIN ASSIGNMENT

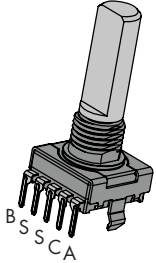

### DRILLING DIAGRAM AND FOOTPRINT

#### THT VERTICAL

View from component side of the PCB

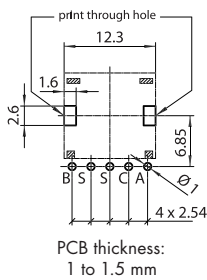

#### THT HORIZONTAL

View from component side of the PCB

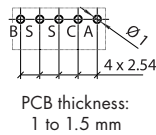

#### SMT VERTICAL

View from component side of the PCB

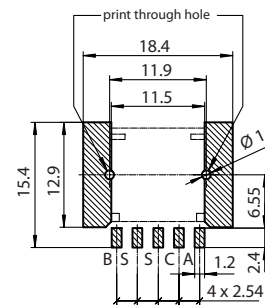

### FRONT PANEL CUT OUT

#### THREADED

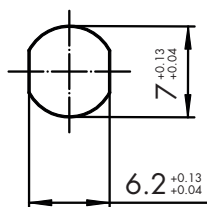

#### NON-THREADED

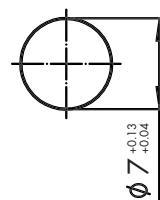

All shaft and bushing types are available for all versions, THT vertical, THT horizontal or SMT vertical (see type key).

### NUT

#### HEX NUT (SUPPLIED)

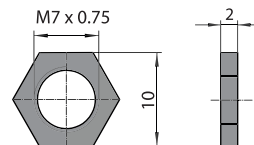

Dimensions in mm  
 Tolerances according to DIN ISO 2768-1 (m), unless otherwise specified

## Circuit diagram

### RECOMMENDED SYSTEM INTERFACE

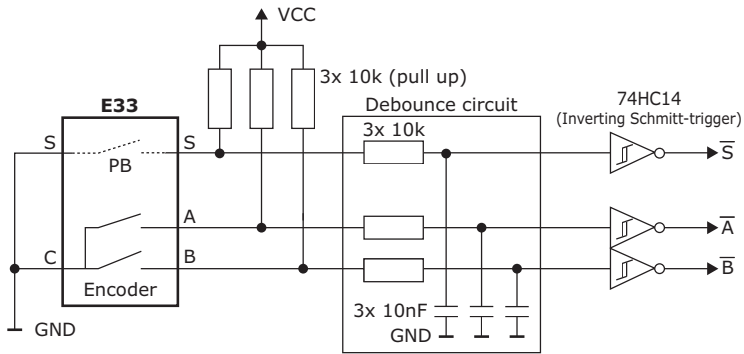

## Ordering information

### ORDERING CODE

E33	-	-	-	-	-	-	-	-	-	-
-----	---	---	---	---	---	---	---	---	---	---

#### ORIENTATION | MOUNTING

- V** THT vertical
- C** THT horizontal
- S** SMT vertical

#### BUSHING

- T** Threaded M7 x 0.75 x 6 mm  
(nut supplied, packed separately)
- N** Non-threaded Ø 7 x 6 mm

#### PUSH BUTTON

- 0** Without push button
- 3** 3 N
- 6** 6 N
- A** 10 N
- E** 14 N

#### RESOLUTION | (RESOLUTION) | SWITCHING TORQUE<sup>1</sup>

<b>1</b>	32 detent	(16 PPR)	2 Ncm
<b>2</b>	16 detent	(8 PPR)	1.5 Ncm
<b>3</b>	16 detent	(8 PPR)	2.5 Ncm
<b>4</b>	32 detent	(8 PPR)	2 Ncm
<b>5</b>	16 detent	(16 PPR)	1.5 Ncm
<b>6</b>	16 detent	(16 PPR)	2.5 Ncm
<b>8</b>	No detent	(16 PPR)	
<b>9</b>	No detent	(8 PPR)	
<b>A</b>	32 detent	(16 PPR)	0.5 Ncm
<b>B</b>	32 detent	(16 PPR)	1 Ncm
<b>C</b>	32 detent	(16 PPR)	1.5 Ncm
<b>D</b>	32 detent	(16 PPR)	3 Ncm
<b>E</b>	16 detent	(8 PPR)	0.5 Ncm
<b>F</b>	16 detent	(8 PPR)	3.5 Ncm
<b>G</b>	16 detent	(8 PPR)	4.5 Ncm

<sup>1</sup> O-ring of IP65 / IP68 shaft sealing may slightly increase switching torque.

#### PACKAGING

- T** Tray (THT or SMT, 10 or 50 pieces, tray size depending on shipping quantity)
- R** Tape & reel with vacuum plug (SMT and THT vertical only, 200 pieces / reel, shafts separated)

#### SHAFT TYPE

For all available shaft types please see next page

#### SHAFT (DELIVERY CONDITION)

- M** Mounted
- S** Separated (snap-in shaft mechanism)
- N** No shaft

#### IP SEALING

- 0** IP60
- 1<sup>1</sup>** IP68 shaft sealing
- 2<sup>1</sup>** IP68 shaft and front panel sealing  
(non-threaded bushing gasket provides IP65, O-ring and gasket is mounted)

<sup>1</sup> O-ring of IP65 / IP68 shaft sealing may slightly increase switching torque

## Ordering information

<sup>1</sup> Threaded bushing: Shaft to be ordered separately; shaft mounting after encoder assembly to front panel (nut does not fit 1/4" shaft diameter). OTHER SHAFTS ARE AVAILABLE ON REQUEST.

### SHAFT TYPES

**Type 00 - no shaft**



**Type 01 - brass**

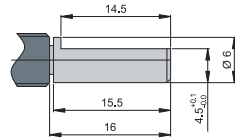

**Type 03 - brass**

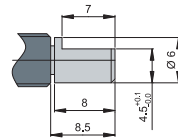

**Type 30 - brass**

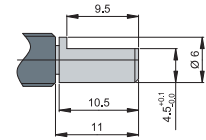

**Type 31 - stainless steel**

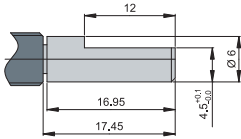

**Type 32 - brass**

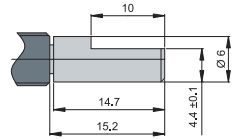

**Type 33 - stainless steel**

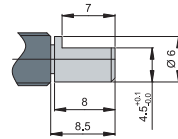

**Type 34 - brass**

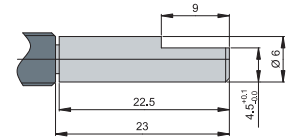

**Type 37 - stainless steel**

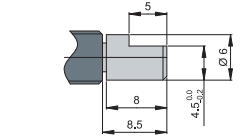

**Type 70 - brass**

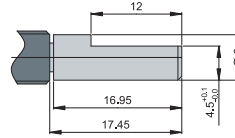

**Type 71 - brass**

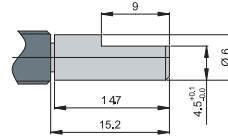

**Type 72 - brass**

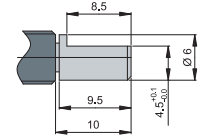

**Type<sup>1</sup> 51 - brass**

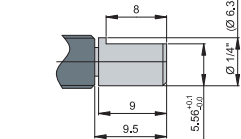

**Type 10 - brass**

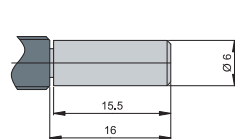

**Type 11 - brass**

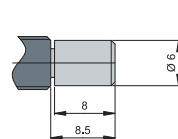

**Type 12 - brass**

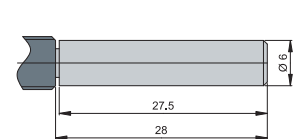

**Type 13 - stainless steel**

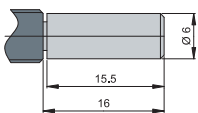

**Type 14 - stainless steel**

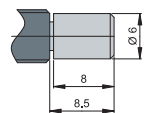

**Type 15 - brass**

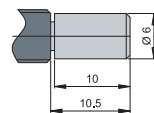

**Type 16 - brass**

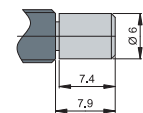

**Type<sup>1</sup> 20 - brass**

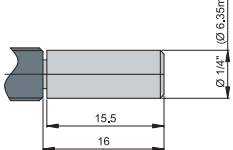

**Type 02 - brass**

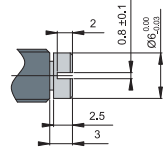

**Type 43 - brass**

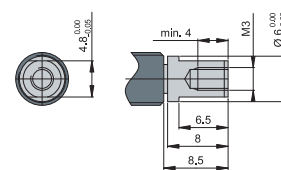

**Type 42 - brass**

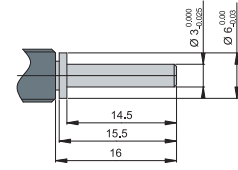

**Type 45 - stainless steel**

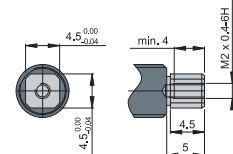

**Type 47 - brass**

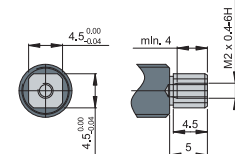

**Type 08 - brass**

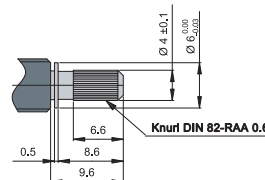

**Type 40 - brass**

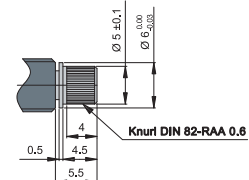

**Type 41 - brass**

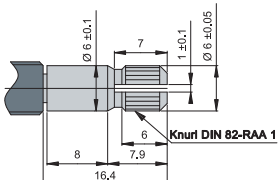

**Type 60 - brass**

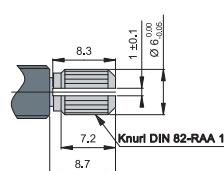

**Type 0H - brass**

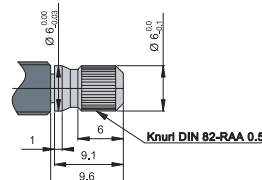

**Type 44 - brass**

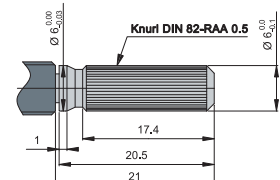

## Ordering information

### PREFERENCE TYPES SELECTION CHART<sup>1</sup>

PUSH BUTTON	IP SEALING	RESOLUTION	SWITCHING TORQUE	THT VERTICAL (THREADED BUSHING <sup>3</sup> )	SMT VERTICAL (NON THREADED BUSHING)
Yes, 6 N	IP60	32 detent (16 PPR)	2 Ncm	E33-VT610-M01T	E33-SN610-M01T
		16 detent (8 PPR)	2.5 Ncm	E33-VT630-M01T	E33-SN630-M01T
	IP68 <sup>2</sup> (Shaft & front panel)	32 detent (16 PPR)	2 Ncm	E33-VT612-M01T	E33-SN612-M01T
		16 detent (8 PPR)	2.5 Ncm	E33-VT632-M01T	E33-SN632-M01T
No	IP60	32 detent (16 PPR)	2 Ncm	E33-VT010-M01T	E33-SN010-M01T
		16 detent (8 PPR)	2.5 Ncm	E33-VT030-M01T	E33-SN030-M01T
	IP68 <sup>2</sup> (Shaft & front panel)	32 detent (16 PPR)	2 Ncm	E33-VT012-M01T	E33-SN012-M01T
		16 detent (8 PPR)	2.5 Ncm	E33-VT032-M01T	E33-SN032-M01T

All of these types are tray packed and fitted with standard shaft type 01.  
<sup>1</sup> For other types | options see ordering code.  
<sup>2</sup> Non-threaded bushing: Gasket provides IP65.  
<sup>3</sup> Nut supplied.

### PACKAGING

Tray: 10 or 50 pieces (depending on shipment quantity, nuts are supplied and packed separately)  
 Tape & reel: 200 pieces (SMT only, shaft and nuts are packed separately)

### TAPE & REEL PACKAGING

#### THT VERTICAL

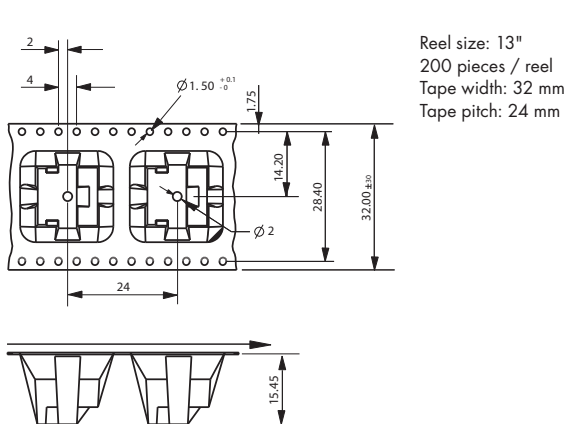

#### SMT VERTICAL

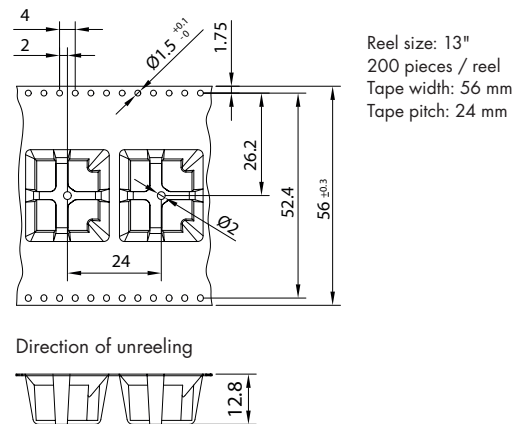

## Ordering information

### ACCESSORIES AND SPARE PARTS

#### HEX NUT

Hex nut M7 x 0.75:

Part number 4516-40 (50 pieces / bag), brass nickel plated

#### O-RING MOUNTING TOOL



Part number: E33-ORING-TOOL

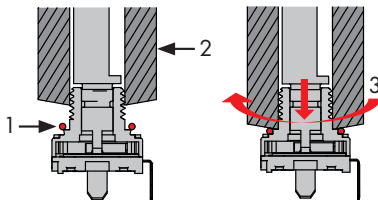

- 1 Slip the lubricated O-ring over the bushing.
- 2 Slide the mounting tool over the bushing.
- 3 While pushing down the O-ring simultaneously rotate the mounting tool.

## Specifications

### MECHANICAL DATA

Positions:	12 positions 32 positions No detent
Switching torque:	16 positions: 0.5, 1.5, 2.5, 3.5 or 4.5 Ncm ( $\pm 30\%$ in new condition) 32 positions: 0.5, 1, 1.5, 2 or 3 Ncm ( $\pm 30\%$ in new condition) No detent
Rotational life:	> 1'000'000 revolutions with 0.5, 1 or 1.5 Ncm switching torque or no detent > 500'000 revolutions with 2 Ncm switching torque > 300'000 revolutions with 2.5 Ncm switching torque > 100'000 revolutions with 3, 3.5 or 4.5 Ncm switching torque (tested at room temperature)
Allowed shaft load:	50 N push, 50 N pull and 50 N side load (static at 20 mm from the support surface)
Fastening torque of nut (front panel mounting):	M7 x 0.75: < 100 Ncm

### ELECTRICAL DATA

Electrical connection:	Pins 0.23 x 0.8 mm
Switching voltage:	< 15 VDC (resistive load)
Switching current:	< 10 mA (resistive load)
Contact resistance:	< 10 $\Omega$ (over the entire rotational life)
Signal   coding:	2-Bit-quadrature
Resolution (pulses per revolution):	16 or 8 PPR per channel (A leads B clockwise)
Rotational speed:	< 60 rpm
Phase shift:	90° ( $\pm 70^\circ$ )
Contact bouncing:	< 2 ms (at 60 rpm)
Dielectric strength:	500 VDC during 60 s (MIL-STD-202G, method 301)
Insulation resistance:	> 1 G $\Omega$ at 500 VDC (in new condition)



## Specifications

### MATERIALS

Shaft:	Brass CuZn38Pb2 or stainless steel 1.4305
Bushing   housing:	Zinc die casting (nickel plated), fiberglass reinforced high performance plastic
Contact surface:	Cu alloy (Au plated)
Soldering leads:	Cu alloy (tin plated)
Hex nut:	Brass (nickel plated)
Housing clamp:	Tinplate
O-rings:	NBR (nitrile rubber), 70 shore A
Front panel sealing:	Threaded bushing: O-ring Non-threaded bushing: EPDM-rubber, 45 shore A, complies with SAE J 18-79

### ENVIRONMENTAL DATA

Operating temperature:	-40 to +85 °C (IEC 60068-2-14)
Storage temperature:	-65 to +125 °C (IEC 60068-2-14, MIL-STD202G, method 107G, condition B-3)
Humidity:	< 93 % relative humidity (MIL-STD-202G, method 103B, condition B)
IP sealing against front panel:	IP60 without sealing IP65 with non-threaded bushing, shaft and front panel sealing IP68 with threaded bushing, shaft and front panel sealing (2 bar, 1h)
Vibration:	29 G <sub>RMS</sub> at 100 to 1'000 Hz (MIL-STD-202G, method 214A, condition 1 h / 15 min)
Shock:	100 G (MIL-STD-202G, method 213B, condition C)
Flammability:	UL94-V0 Gasket UL94-HB

### SOLDERING CONDITIONS

Hand soldering:	< 300 °C during 3 s
Wave soldering:	< 280 °C during 5 s
Reflow soldering:	according to IPC/JEDEC J-STD-020C*

### MECHANICAL DATA FOR PUSH BUTTON

Actuation force:	3, 6, 10 or 14 N (±30 % in new condition)
Travel:	0.5 (±0.2) mm
Lifecycles:	> 200'000 cycles (tested at room temperature)

### ELECTRICAL DATA FOR PUSH BUTTON

Switching voltage:	< 15 VDC (resistive load)
Switching current:	< 10 mA (resistive load)
Contact bouncing:	< 2 ms (at 2 Hz)

### MATERIALS FOR PUSH BUTTON

Contact surface:	Cu alloy (Au plated)
Snap dome:	Stainless steel (Au plated)

#### \*REFLOW SOLDERING

Temperatures or process durations exceeding rated maximum conditions may harm switch function.

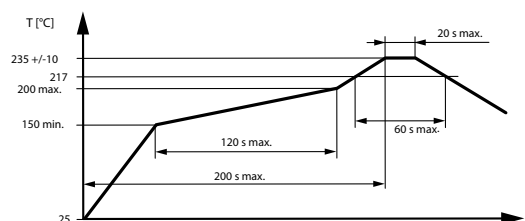

©Copyright 2018 by Elma Electronic AG, CH-8620 Wetzikon. Subject to technical modifications, all data supplied without liability.

Please contact our sales team for more details.

China: +86 21 5866 5908  
 France: +33 388 56 72 50

Germany: +49 7231 97 34 0  
 Israel: +972 3 930 50 25

Singapore: +65 6479 8552  
 Switzerland: +41 44 933 41 11

United Kingdom: +44 1234 838 822  
 United States: +1 510 656 3400