

RoHS compliant

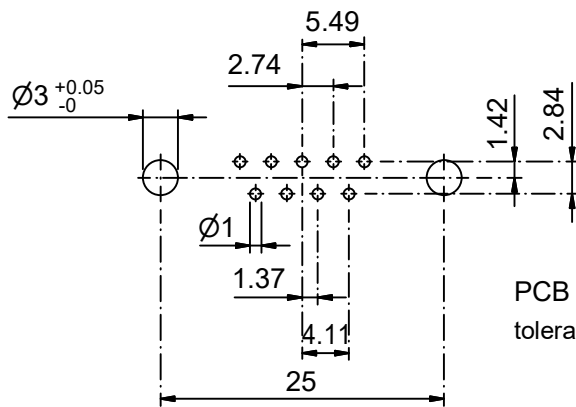
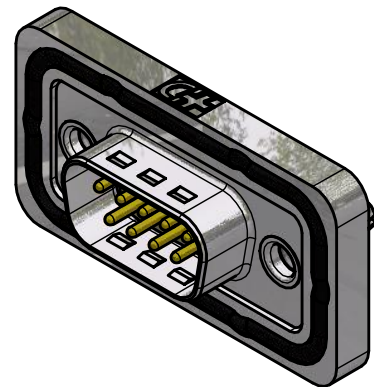
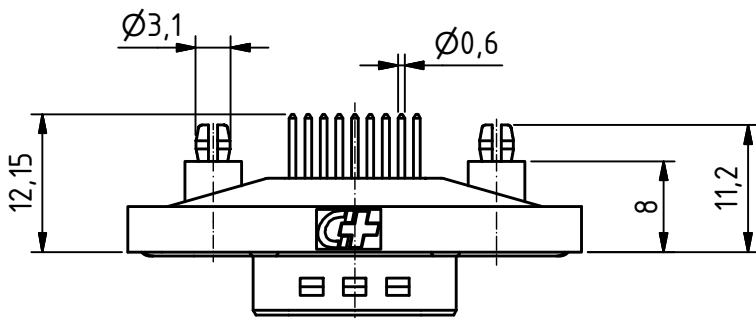
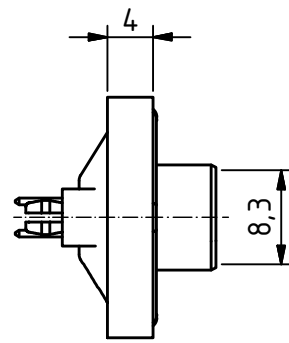
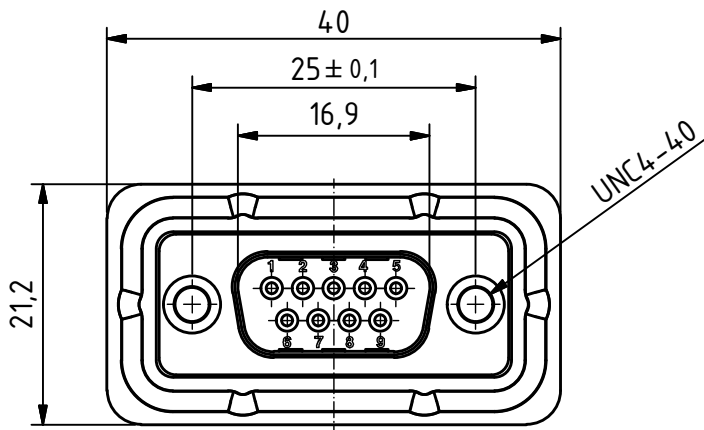

PCB Layout
tolerances +/-0.1

Waterproof IP68
Frame with O-ring sealing for back panel mounting

MATERIALS

- Insulator: Thermoplastic UL 94-V-0 white
- Frame: Zinc diecasting nickel plated
- Contact: Machined / Copper alloy
- Contact finish: Quality class 2
- Shell: steel tin plated

CHARAKTERISTICS

- Working voltage: 125V
- Current rating: 7.5A
- Contact resistance: max. 10mΩ - DIN41652
- Insulation resistance: >5GΩ
- Temperature range: -55° to +125°C

Product is
suitable for
Wave Solder
Process

General tolerances (Deltron standard)			
size in mm	> 0.5 up to 3	> 3 up to 6	> 6 up to 30
tolerances	±0.1	±0.2	±0.3

	All dimensions in mm	Rev.	Rev.	Rev.	DE017144		
		Rev.	Rev.	Rev.	part no.		
DTSWM09PY/2M86UN				1.5:1 scale	drawn	11.02.2016	mw
					checked		
				approved			
 CONNECT 2 CUSTOMIZE				Industrie Neuhof 8c CH-3422 Kirchberg www.d-sub.swiss		K062402 drawing no.	