

Data sheet | Item number: 2060-1452/998-404

THR PCB terminal block; push-button; 0.75 mm²; Pin spacing 4 mm; 2-pole;
 Push-in CAGE CLAMP®; in tape-and-reel packaging; 0,75 mm²; white

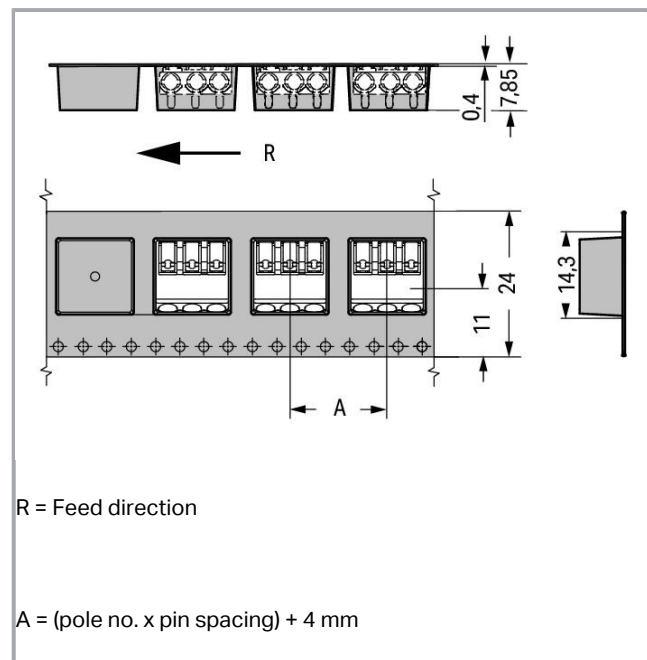

www.wago.com/2060-1452/998-404

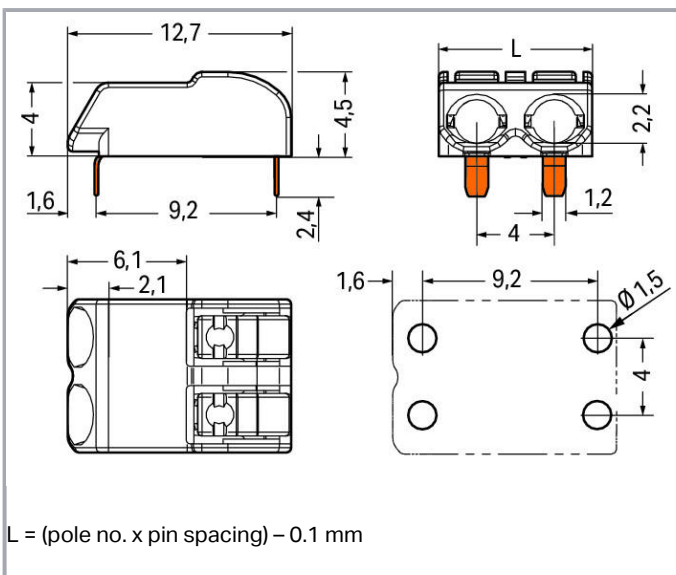
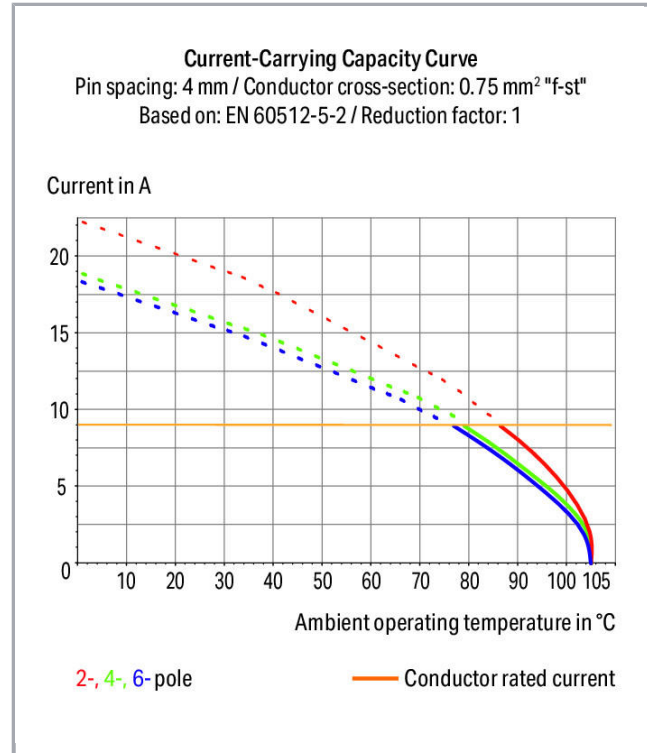

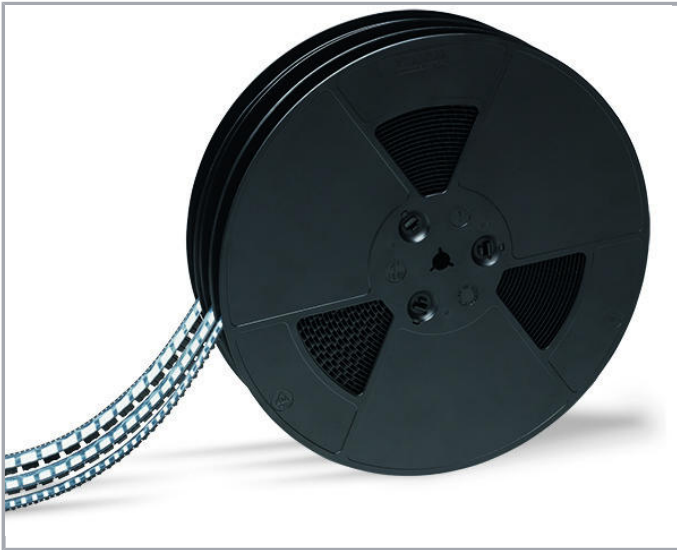

Item description

- THR PCB terminal blocks with push-buttons and Push-in CAGE CLAMP[®] connection
- Push-in termination of solid and ferruled conductors
- Convenient termination/removal of fine-stranded conductors via push-buttons
- Just 4.5 mm tall
- Available in tape-and-reel packaging for automated assembly
- Also suitable for wave soldering

Note:

Application note:

Suitable for lead-free, reflow-soldering profiles per DIN EN 61760-1 and IEC 60068-2-58 up to max. 260 °C peak temperature. Due to customer-specific variables (e.g., component configuration and orientation, type of soldering machine, solder paste), trial runs are recommended to ensure product and process compatibility under actual manufacturing conditions.

Recommendation:

Recommendation for stencil:

150 µm material thickness

The stencil hole diameter is identical to the outer diameter of the metal-plated PCB hole.

Data

Electrical data

Ratings per IEC/EN 60664-1

Rated voltage (III / 3)	63 V
Rated impulse voltage (III / 3)	2.5 kV
Rated voltage (III / 2)	160 V
Rated impulse voltage (III / 2)	2.5 kV
Rated voltage (II / 2)	320 V
Rated impulse voltage (II / 2)	2.5 kV
Rated current	9 A

Approvals per UL 1977

Rated voltage per UL 1977 (factory wiring only)	320 V
Rated current per UL 1977 (factory wiring only)	9 A

Connection data

Connection technology	Push-in CAGE CLAMP®
Actuation type	Push-button
Solid conductor	0.2 ... 0.75 mm ² / 24 ... 18 AWG
Fine-stranded conductor	0.2 ... 0.75 mm ² / 24 ... 18 AWG
Fine-stranded conductor with ferrule with plastic collar	0.25 ... 0.34 mm ²
Fine-stranded conductor with ferrule without plastic collar	0.25 ... 0.34 mm ²
Strip length	6 ... 7 mm / 0.24 ... 0.28 inch
Conductor entry angle to the PCB	0°
Total number of connection points	2
Total number of potentials	2
Number of connection types	1
Number of levels	1
No. of poles	2

Geometrical Data

Pin spacing	4 mm / 0.157 inch
Width	7.9 mm / 0.311 inch
Height	6.9 mm / 0.272 inch
Height from the surface	4.5 mm / 0.177 inch
Depth	12.7 mm / 0.5 inch
Solder pin length	2.4 mm
Solder pin dimensions	1.2 x 0.75 mm
Reel diameter of tape-and-reel packaging	330 mm
Tape width	24 mm

PCB contact

PCB contact	THR
Solder pin arrangement	over the entire terminal strip, in line
Number of solder pins per potential	2

Material Data





Color	white
Material group	I
Insulating material	Polyphthalamide (PPA GF)
Flammability class per UL94	V0
Clamping spring material	Chrome nickel spring steel (CrNi)
Contact material	Copper alloy
Contact plating	tin-plated
Weight	0.518 g

Environmental Requirements

Limit temperature range	-60 ... +105 °C
-------------------------	-----------------

Approvals / Certificates

Country specific Approvals



Logo	Approval	Additional Approval Text	Certificate name
	CCA DEKRA Certification B.V.	EN 60947	NTR NL- 7724
	CCA DEKRA Certification B.V.	EN 60838	NTR NL 2168246
	KEMA/KEUR DEKRA Certification B.V.	EN 60947	71-108183
	KEMA/KEUR DEKRA Certification B.V.	EN 60838	2168246.01
	KEMA/KEUR DEKRA Certification B.V.	EN 60998	71-108181

UL-Approvals



Logo	Approval	Additional Approval Text	Certificate name
	cURus Underwriters Laboratories Inc.	UL 1977	E45171- 20111005

Compatible products

ferrule

	Item no.: 216-131 Ferrule; Sleeve for 0.25 mm ² / AWG 24; uninsulated; electro-tin plated	www.wago.com/216-131
	Item no.: 216-132 Ferrule; Sleeve for 0.34 mm ² / AWG 24; uninsulated; electro-tin plated	www.wago.com/216-132
	Item no.: 216-301 Ferrule; Sleeve for 0.25 mm ² / AWG 24; insulated; electro-tin plated; yellow	www.wago.com/216-301
	Item no.: 216-302 Ferrule; Sleeve for 0.34 mm ² / 22 AWG; insulated; electro-tin plated; green	www.wago.com/216-302

tools

	Item no.: 2060-189 Operating tool; made of insulating material; for 2060 Series	www.wago.com/2060-189
	Item no.: 206-860 Operating tool; for 2060 Series	www.wago.com/206-860

Downloads

Documentation

Additional Information

Technical explanations	Apr 3, 2019	pdf 3.6 MB	Download
------------------------	-------------	---------------	----------

CAD/CAE-Data

CAD data

3D Download 2060-1452/998-404	URL	Download
-------------------------------	-----	----------



Subject to changes.

WAGO Kontakttechnik GmbH & Co. KG

Hansastr. 27

32423 Minden

Phone: +49571 887-0 | Fax: +49571 887-169

Email: info.de@wago.com | Web: www.wago.com

Do you have any questions about our products?

We are always happy to take your call at +49 (571) 887-44222.